

**MISSISSIPPI DEPARTMENT OF TRANSPORTATION  
BRIDGE DESIGN DIVISION**

---

**BRIDGE DESIGN MANUAL**

To provide MDOT Bridge Design engineers a guide to the design criteria and detailing procedures for the preparation of contract bridge construction plans.

last modified (3.2010)

---

REVISIONS	
DATE:	REASON:
3/5/2010	Added LRFD standards.





# Forward

The Bridge Design Manual is a publication of the Mississippi Department of Transportation (MDOT) - Bridge Division. The specific objective of this manual is to provide MDOT bridge design engineers with a standard guide to MDOT policies and procedures for preparation of highway bridge contract plans. This manual should be used in conjunction with current AASHTO design specifications.



## **Disclaimer**

The content of this manual is being provided "as is" with the understanding that the documentation is subject to change without notice. MDOT makes no warranty, expressed or implied, as to the documentation, function or accuracy of the information described within this manual and no responsibility is assumed by the Mississippi Department of Transportation in any connection therewith. MDOT will not be responsible or liable for any use or misuse of this information.

The information provided herein shall not be distributed to, used by or copied by any person, company or organization outside of your company.

Mississippi Department of Transportation  
Bridge Division  
P.O. Box 1850  
Jackson, MS 39215-1850



# Table Of Contents

Forward .....	1
Disclaimer .....	3
Table Of Contents .....	5
Preliminary Design .....	7
Hydraulic Sites .....	7
Grade Separations .....	7
Highway Crossings .....	7
Railroad Crossings .....	8
Miscellaneous .....	10
Beam Design Details .....	11
Beam Dimensions .....	11
Beam Section Properties .....	12
Design Parameters .....	13
General .....	13
Strands .....	16
Diaphragms .....	16
Bulb-T Design Procedure .....	17
Span Design Details .....	19
General .....	19
Simple Spans .....	21
Continuous Spans .....	22
Pad Design Details .....	23
General .....	23
Bent Design Details .....	25
General .....	25
End Bents .....	25
Intermediate Bents .....	25
Miscellaneous Design Details .....	27
Bridge Joints .....	27
Slope Paving Details .....	28
Pile Encasement .....	29
Reinforcement Development .....	29
Bridge Pay Items .....	29
Bridge Title Block .....	29
Standard Design Detail Sheets .....	31
Miscellaneous Span Details Standard Sheet .....	31
32" Rail Standard Sheet .....	32
42" Rail Standard Sheet .....	33
14", 16", 18" & 20" Square Prestressed Concrete Pile (Non-Seismic) .....	34
14", 16", 18" & 20" Square Prestressed Concrete Pile (Seismic) .....	35
24", 30" & 36" Square Prestressed Concrete Pile (Non-Seismic) .....	36
24", 30" & 36" Square Prestressed Concrete Pile (Seismic) .....	37





# Preliminary Design

The Preliminary Plan preparation stage is perhaps the most important phase of bridge design because it is the basis for the final design. The Preliminary Plan should completely define the bridge geometry so the final structural design by the bridge division can take place with minimal revision.

## Hydraulic Sites

A Preliminary Layout of the proposed bridge(s) should include the following:

1. A plan view and elevation showing an accurate ground line for each bridge.
2. The location of the channel and all proposed bents as well as the location of any existing substructure.
3. If required, the size and location of spur dikes should be clearly indicated on the plans.
4. A typical roadway section for the bridge(s).
5. A detail showing proposed channel modifications and bank stabilization measures.
6. Drainage Data should include the Drainage Area, Design Discharge and Effective Area provided.
7. The plan view should show direction of flow and the Design Stage should be indicated on the elevation view.
8. The plan view should show a North Arrow.

## Grade Separations

### Highway Crossings

1. An accurate topographic survey is required to address drainage and clearance issues.
2. All existing structures (i.e. box culverts, piling, pipes, etc.) should be clearly indicated on the plan and elevation views of the proposed bridge.
3. Ideally the crossing should be made at 90 Degrees. However, since this is impossible in most situations, a skew angle that makes the bents parallel to the roadway being crossed should be used. In cases where excessive skews are used, special designs must be considered.
4. A clear path for drainage should be provided on each side of the highway being crossed.
5. ~~Frame type structures are typically used for the interior bents on grade separations. These frame bents usually consist of a reinforced concrete cap supported by round or diamond shaped columns with either pile supported footings or drilled shafts. In general, diamond-shaped columns are considered more aesthetically pleasing.~~
6. Deck drains should be omitted in spans over the roadway being crossed.

7. The following guidelines shown in Figure 1 should be followed in determining roadway clearances:

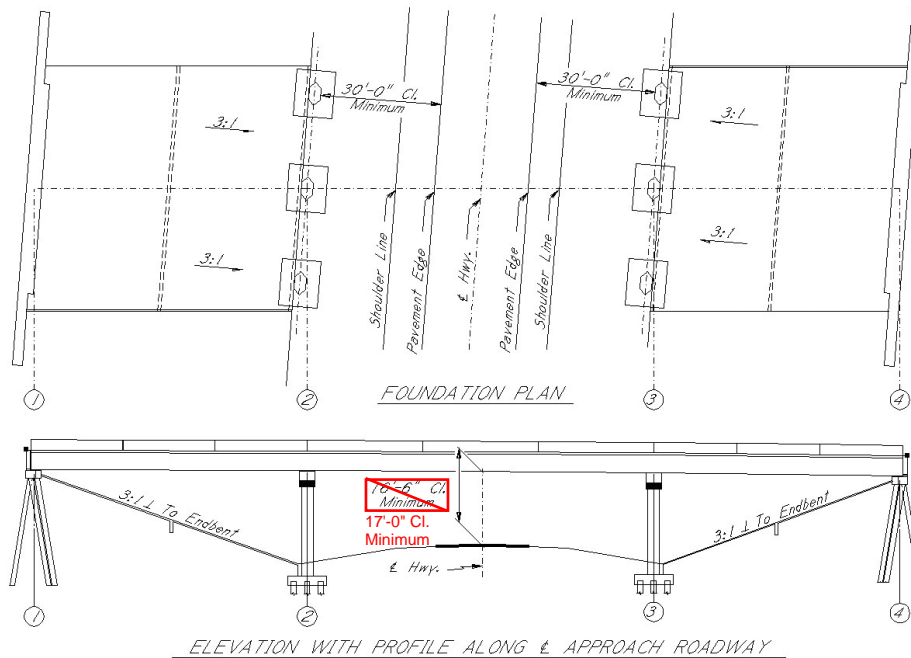

Figure 1: Highway Clearances

#### Horizontal Clearances:

Horizontal clearances are measured perpendicular from the through-traffic lane to the obstruction (i.e. column or bent). A horizontal clearance of 30'-0" (minimum) is valid for most situations; however, the clearance used should be in accordance with AASHTO Specifications.

#### Vertical Clearances:

Vertical clearances should be computed at the intersection of the lowest girder line with the shoulder lines, edges of pavement and crown line of each roadway being crossed. The clearance must exceed ~~16'-6"~~ 17'-0" at all of these locations.

#### Railroad Crossings

1. An accurate topographic survey is required to address drainage and clearance issues.
2. All existing structures (i.e. box culverts, piling, pipes, etc.) should be clearly indicated on the plan and elevation views of the proposed bridge.
3. The crossing should be made such that the bents are parallel to the railroad. In cases where excessive skews are used; special designs must be considered.
4. A clear path for drainage should be provided on each side of the railroad beyond the right-of-way. Piers and end slopes shall be located such that they do not interfere with railroad drainage ditches.
5. ~~Frame type structures are typically used for the interior bents on this type of structure. These frame bents normally consist of a reinforced cap supported by round columns with either pile supported footings or drilled shafts.~~
6. The Railroad shall be furnished a Preliminary Drawing for approval. The drawing shall consist of an elevation and plan view of the proposed bridge containing the following information:
  - a. Railroad Valuation Station and distance from the nearest milepost at intersection of centerline of the track and centerline of the bridge shall be shown on the plan view.
  - b. Horizontal and Vertical clearances to all obstructions.

- c. A signature block for the railroad to approve the plans "For Clearances Only" should be included on both plan and elevation views.
7. Deck drains should be omitted in spans over the railroad.
8. Horizontal and Vertical clearances are computed inside an area over the tracks measured 18'-0" horizontally on one side of the track and 12'-6" horizontally on the other side. Horizontal clearances should be measured perpendicular from the center line of the railroad to the obstruction (i.e. column, bent or piling) and should not exceed 18'-0" and 12'-6". Vertical clearances are computed inside this area described above and must be a minimum of 23'-6" from the top of track to the lowest girder line.

The following guidelines shown in Figure 2 should be followed in determining railroad clearances:

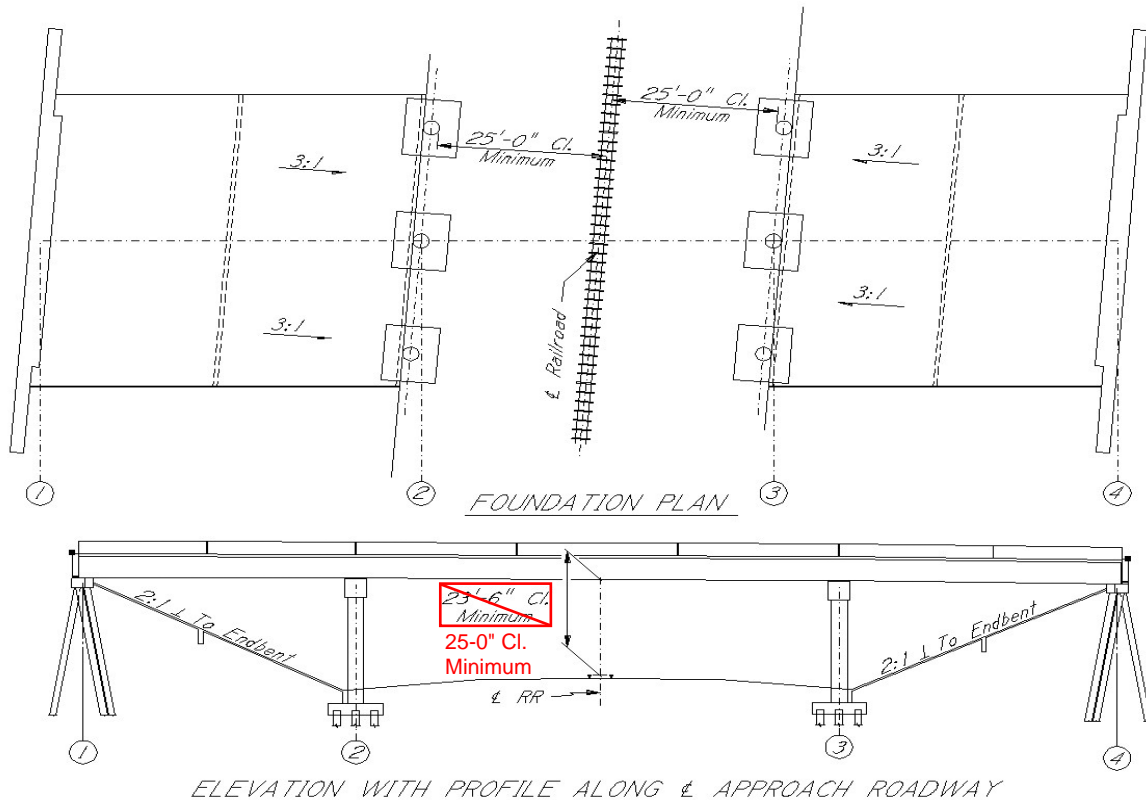

Figure 2: Railway Clearances

9. Abutments and/or piers for overhead bridge structures shall be located to clear the ditches of a typical track roadbed section.
10. A standard vertical clearance above the track shall be provided. This clearance should be measured from top of the rail to the lowest point on the structure in an area 8 feet either side of centerline of track. Within the railroad's ROW.
11. Temporary construction clearances may be less if approved by the railroad.
12. Horizontal clearances may need to be increased if a maintenance roadway is required by the railroad. If horizontal clearances are less than 25 feet, a crash wall will be required. The crashwall shall conform to the latest A.R.E.M.A. requirements and are subject to additional requirements by the railroad.
13. Clearances may require adjustment to provide for any planned changes in the trackage, including the change in track centers and raising of the tracks.

14. Shoring or sheeting protection shall be provided when excavating adjacent to an active railroad track. However, if both of the conditions shown in Figure 3 are satisfied shoring will not be required by the railroad.

**Temporary Slope:** When temporary excavation does not encroach upon a 1:1 (1 horizontal: 1 vertical) theoretical slope line starting 2 foot 2 inches below top of rail and at 10 feet minimum from centerline of the track.

**Finish Slope:** When excavation does not encroach upon a 1.5:1 (1.5 horizontal: 1 vertical) theoretical slope line starting 2 foot 2 inches below top of rail and at 10 feet minimum from centerline of the track.

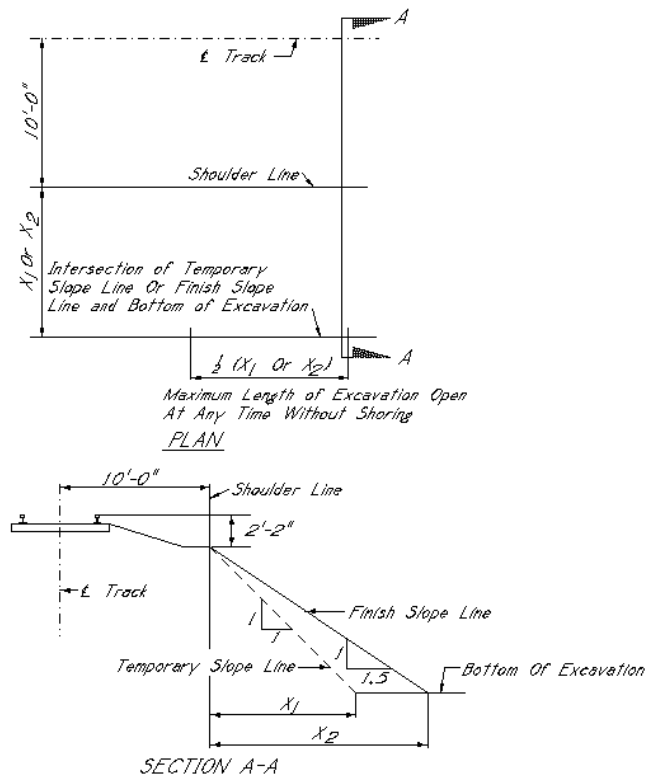

Figure 3: Shoring Requirements

15. The criteria given above can be used in most situations. However, some railroad company's clearance criteria or other policies may differ from those described. Therefore, it is the designer's responsibility to make sure that the clearances and details shown on the plans are approved by the railroad. Prior to completion of the plans an approved copy of the bridge preliminary signed by the railroad company should be on file.

## Miscellaneous

1. Bridges designed to accommodate pedestrian traffic alongside vehicle traffic will be reviewed on a case by case basis to determine the need for a separate barrier for pedestrians. The need for a separate bridge railing adjacent to the pedestrian walkway should be based upon the volume and speed of the roadway traffic, lane width, curb offset, and alignment.

## Beam Design Details

Bridge Division utilizes two types of prestressed concrete girders for the design of bridges:

1. AASHTO Shapes
2. Bulb-T Shapes

Steel beams, welded plate girders and other special designs are used on an as needed basis.

See the accompanying "Prestressed Beam Reference Guide" for beam reinforcing details, bearing pad details and a strand pattern guide.

### Beam Dimensions

Standard beam dimensions for both AASHTO and Bulb-T beams are shown below.

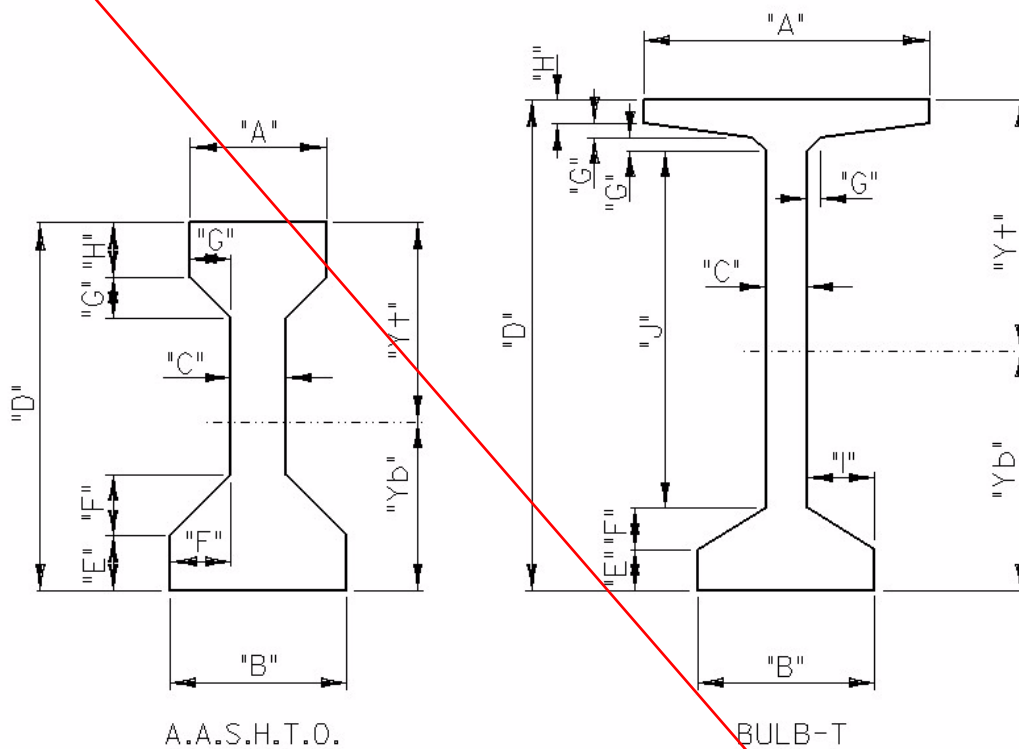

Type	"A"	"B"	"C"	"D"	"E"	"F"	"G"	"H"	"I"	"J"
I	1'-0"	1'-4"	6"	2'-4"	5"	5"	3"	4"		
I+2	1'-2"	1'-6"	8"	2'-4"	5"	5"	3"	4"		
II	1'-0"	1'-6"	6"	3'-0"	6"	6"	3"	6"		
II+2	1'-2"	1'-8"	8"	3'-0"	6"	6"	3"	6"		
III	1'-4"	1'-10"	7"	3'-9"	7"	7 1/2"	4 1/2"	7"		
III+2	1'-6"	2'-0"	9"	3'-9"	7"	7 1/2"	4 1/2"	7"		
IV	1'-8"	2'-2"	8"	4'-6"	8"	9"	6"	8"		
IV+2	1'-10"	2'-4"	10"	4'-6"	8"	9"	6"	8"		
BT-54	3'-6"	2'-2"	6"	4'-6"	6"	4 1/2"	2"	3 1/2"	10"	3'-0"
BT-63	3'-6"	2'-2"	6"	5'-3"	6"	4 1/2"	2"	3 1/2"	10"	3'-9"
BT-72	3'-6"	2'-2"	6"	6'-0"	6"	4 1/2"	2"	3 1/2"	10"	4'-6"

## Beam Section Properties

Standard beam section properties for both AASHTO and Bulb-T Beams are shown below.

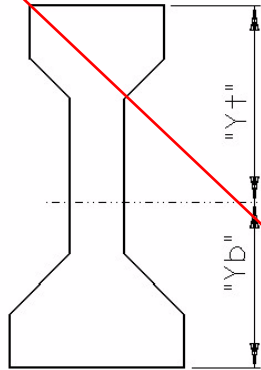

A.A.S.H.T.O.

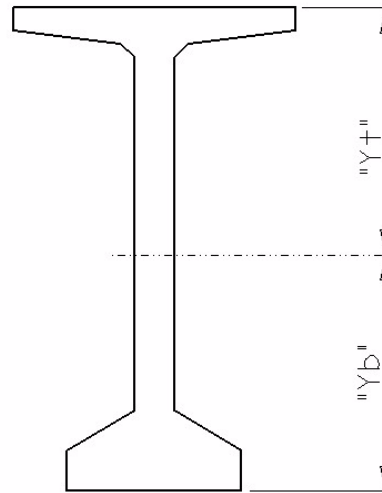

BULB-T

Type	Area (in. <sup>2</sup> )	Wt. (#/ft.)	I (in. <sup>4</sup> )	Yb (in.)	Yt (in.)	St (in. <sup>3</sup> )	Sb (in. <sup>3</sup> )
I	276	288	22,750	12.59	15.41	1,476	1,807
I+2	332	346	26,502	12.83	15.17	1,747	2,066
II	369	384	50,980	15.83	20.17	2,527	3,220
II+2	441	459	59,039	16.18	19.82	2,979	3,649
III	560	583	125,390	20.27	24.73	5,070	6,186
III+2	650	677	140,962	20.57	24.43	5,770	6,853
IV	789	822	260,730	24.73	29.27	8,908	10,543
IV+2	897	934	287,464	25.00	29.00	9,913	11,498
BT-54	659	686	268,045	27.63	26.37	10,165	9,701
BT-63	713	743	392,509	32.12	30.88	12,711	12,220
BT-72	767	799	545,850	36.60	35.40	15,419	14,914

## Design Parameters

### General

1. The 28-day compressive strength for beam concrete shall be 5,000 p.s.i. Strengths of 5,500 p.s.i. and 6,000 p.s.i. can be used as required by design.
2. Beams are designed in two ways; Simple or Continuous for Live Load (See Figures 4 and 5). The Continuous for Live Load design is different in that the shear for the beam design is based on the combined effects of all continuous spans loaded.

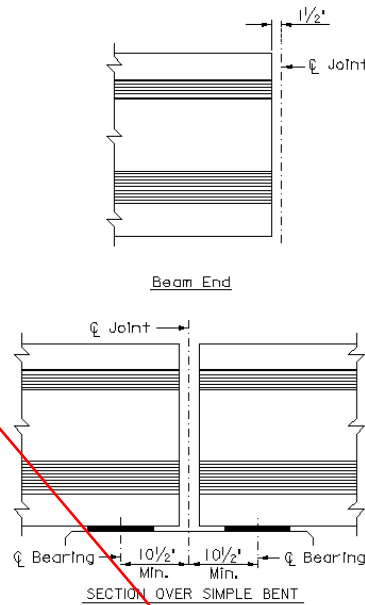

Figure 4: Simple Beam

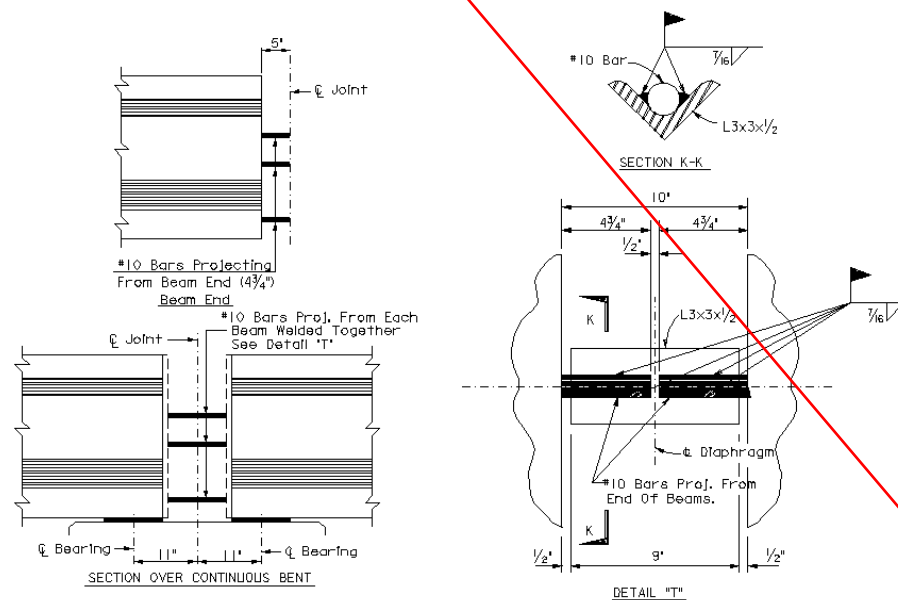

Figure 5: Continuous Beam

3. The continuous ends of beams are connected using #10 bars as shown in Figure 5. The location of these bars projecting from the beam ends is compiled in the Prestressed Beam Reference Guide.

4. The beam spacing is determined as shown in Figure 6.

**General Considerations:**

- a. Roadway Width is the Gutter to Gutter dimension of the bridge.
- b. The value "BMS" is the perpendicular beam spacing between adjacent beams. This value is normally rounded to the nearest one-half (1/2) inch.
- c. For bridges that are in Horizontal Curves, the Exterior Beam is placed on a chord located "do" from the slab edge at centerline joints of the span. The Interior Beams are parallel to a chord drawn from the intersection of the centerline of approach roadway and centerline joints of the span.

*The term "do" is the cantilever dimension of the span measured from centerline exterior beam. ~~This dimension is 3'-2" for AASHTO girders and is normally 3'-9" for Bulb-T girders~~ (However, the designer may need to vary this dimension based on "de" to allow for drain holes or scuppers).*

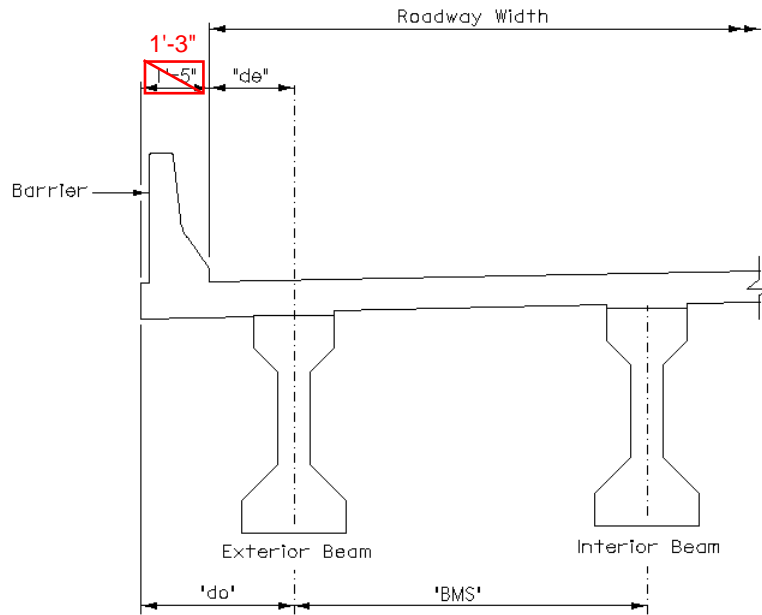

Figure 6: Beam Spacing



5. When uniform grades or vertical curves are used in an alignment, the prestressed beams should be checked to insure no modifications to the beam ends, beam length or bearing pads will be required. Refer to the details shown in Figure 7 for an explanation.

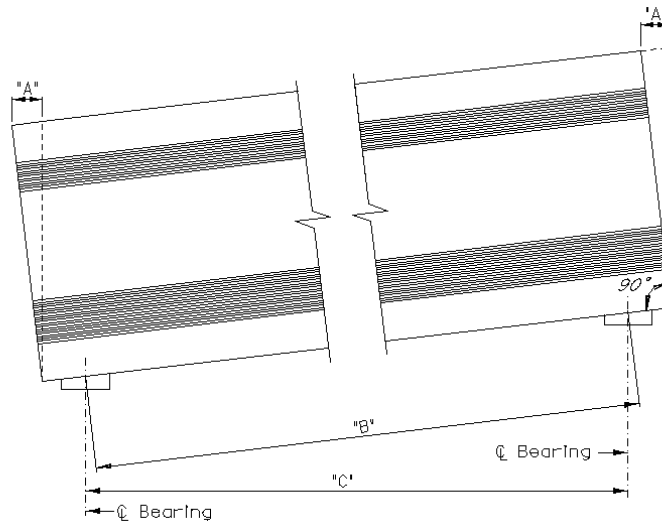

Figure 7: Modifying Beams on Grade

- B = Beam Length minus the distance from Beam End to Bearing (Each End)
- C = Horizontal Distance from Bearing to Bearing
- A = Beam End Bevel

Prestressed beams should be modified when the following conditions are met:

- a. Beam End Treatment
  - Uniform Slope: When Prestressed Beams are to be used on grades which cause "A" to be equal to or greater than 1/2", the beam ends should be cast as shown by the dotted line so that the ends of the beam will be vertical when set on the bents.
  - Vertical Curve: In those cases where the slope of the beams of a given bridge vary and "A" equals or exceeds 1/2", the beams should be cast with ends sloped to the nearest 1/2" increments. This will result in individual beam ends being more nearly vertical when beams are set on bents.
- b. Adjusted Beam Length
  - When the slope of an individual beam is such that "B" (Slope Dimension) exceeds "C" (Horizontal Dimension) by 1/2" or more, the beam length should be increased by an increment equal to "B" minus "C"
- c. Beveled Neoprene Pads
  - When the slope of an individual beam is equal to or greater than 1/8" per foot, the Neoprene Bearing Pads must be beveled. The pad slope should be rounded to the nearest 1/8" per foot slope. Laminated Pads cannot be beveled. In the case where Laminated Pads must be used, a sloped steel plate (sole plate) should be placed between the beam and the Laminated Pad.

## Strands

Debonded strands are current practice.

1. Bridge Division policy is to drape strands instead of debonding. However, debonding may be used with permission from the Bridge Engineer on straight strands in certain situations to reduce stresses in the beam.
2. The drape points on a beam are located one tenth (1/10) of the span length from each side of centerline of beam.
3. If draped strands are required, a maximum number of twelve (12) draped strands or a minimum of four (4) draped strands are allowed.
4. If the beam design used does not require straight strands in the top of the beam, #5 bars (or 1/2" strands stressed to 2,000#s) must be used in the top of the beam to aid in positioning shear steel.
5. For all beam types, the lowest row of strands shall be 2 1/2" above the bottom of the beam. The highest strand location is 3" from the top of the beam.
6. Bulb-T's shall be designed using a 1/2" oversized strand. On a project that contains a mixture of AASHTO and Bulb-T Beams a determination should be made if the 1/2" oversized strand will be used on the entire project. On the plans this strand type should be designated as: Oversized 1/2"  $\phi$  270 K-LR.

### 1/2" Oversized Strand Properties

$f_s'$	=	270 ksi
$f_{pu}$	=	270 ksi
pull	=	75%
$f_y/f_s'$	=	90%
Diameter	=	0.5620 in.
Area	=	0.1670 in. <sup>2</sup>
$C_1$	=	4.86 ksi
$C_2$	=	0.05 ksi
$C_3$	=	0.10 ksi
$C_{rsi}$	=	1.5 ksi

## Diaphragms

1. Intermediate Diaphragms are required when the unbraced length of the girder exceeds the following:  

40 Feet - AASHTO Girders  
50 Feet - Bulb-T Beams

(The weight of these diaphragms should be considered in the design of the beam.)
2. In order to allow the reinforcing of the Intermediate Diaphragm to pass through the beam webs, beams with draped strands require 2"x3" slots in the beam web and beams with straight strands require 2" diameter holes in the beam web.
3. For reinforcing passing through the beam webs at End Diaphragms 2" diameter holes are required. However, when the skew is greater than 15 degrees diaphragm inserts are required instead.
4. Intermediate Diaphragms that cross joint beams on skewed spans should cross at the intersection of the joint beam and beam centerline.

## Bulb-T Design Procedure

Bulb-T Beams shall be designed using the MDOT design procedure as outlined below:

1. Perform initial design in approved commercial prestressed concrete beam design program. Bridge Division licenses two programs CONSPAN and PSBeam.
  - a. In the design, include the additional weight of two inches (2") of concrete over the entire length of the beam. (This additional two inches of concrete is not to be inputted as haunch which will result in an increased composite cross-sectional area, this is merely to be an additional non-composite dead load.)
  - b. Include any diaphragm weight
  - c. Distribute the railing equally over all beams
  - d. Design the beam with as little tension as possible at the bottom in the middle of the beam (No tension if possible).
 

*Note: If you design using PSBeam v2.2, input diaphragm loading as an "equivalent" distributed Non-composite dead load so that the correct multiplier (3.0 instead of 2.3) is applied. Also, PSBeam restricts point load locations to half, quarter, and third points.*
  - e. Adjust Release Strength: Run iterations adjusting Release strength,  $f_{ci}$  (in PSBeam and CONSPAN) until lowest Release strength that results in passing release stresses is obtained (Take the highest overstressed value and divide by 0.6, then round up to next 100 psi and reiterate using this value for  $f_{ci}$ ). Use this run's results for determination of Camber Limit.
  - f. Use Debonding if necessary (Debond to nearest tenth points, one pair of strands at a time until compression does not exceed allowable stress by more than 5 %.).
2. Using the design from the commercial design program, run the In-House beam design program (HDBRG963.EXE).
  - a. Run the design using the total number of strands used in the commercial design program.
  - b. Be sure to include the load for the additional two inches (2") of concrete across the top flange for the entire length of the beam
  - c. Run the design for the three cases we already design for (Stress, Ultimate Moment, and Slab).
    - Stress Design uses the full width top beam flange. Used to check the final stresses in the beam.
    - Ultimate Moment Design uses a top beam flange equal to the web thickness. Used to check the Ultimate moment values (to see if they change. A change indicates the compression block is in the top flanges)
    - Slab Design uses one half of the top beam flange width. Used for the slab design values.
3. From the output of both the In-House and commercial program designs, the Maximum Average Beam Fillet is determined.
  - a. Use the Deflection Diagram (A, B, C) Values from the In-House Program (Stress Design).
    - A - Total recommended allowance for deflection
    - B - Estimated deflection due to dead load of slab and rail
    - C - (A-B) Net initial camber in riding surface, which includes an allowance for creep
  - b. Use the Camber Limit from the Commercial Design program (Camber Limit = Erection Prestress + Erection Self Weight)
  - c. The table below shows the design values A, B, C & Camber Limit (CL) for two continuous beams designed using the procedure outlined above. These values will be used in the following example to demonstrate how to calculate the beam fillet. For this example, a bridge with two span lengths (120 and 128) are being designed continuous. A maximum fillet height must be determined and used to "check" each beam design.

Beam Length	In-House			CONSPAN
	A	B	C	CL
120 ft.	2 5/16	1 3/8	15/16	3 13/16
128 ft.	3 7/16	1 3/4	1 11/16	3 7/8

- d. Using the above output, two fillet values (Maximum Average Fillet and Design Fillet) will be calculated. The Maximum Average Fillet will be used to check the allowable stress in the beam. The Design Fillet is the fillet height at the end of the beam which prevents the cambered beam from encroaching into the slab thickness. The Design Fillet will be used in the section depth calculations for cap elevations and will be the fillet height detailed in the final plans.
- e. First, calculate the Adjusted Fillet.  
 Adjusted Fillet = Calculated Fillet + Allowance for deck Cross-Slope  
 Where: Calculated Fillet = CL - A  
 Allowance for Cross-Slope = (Deck Cross-Slope \* Beam Top Flange Width)/2

Beam Length	Calculated Fillet	Deck X-Slope	Allow. X-Slope	Adjusted Fillet
120 ft.	1 1/2	0.02	7/16	1 15/16
128 ft.	7/16	0.02	7/16	1*

\*Note: The adjusted fillet was adjusted to be 1" minimum.

- f. Set the Design Fillet height by choosing the largest Adjusted Fillet of the beams in the continuous span (Design Fillet Height is the fillet height at the centerline of the beam cross-section, which, will also be used in the section depth calculations for cap elevations.)

Beam Length	Adjusted Fillet
120 ft.	1 15/16
128 ft.	1*

- g. Maximum Average Fillet = Design Fillet + (A/2)

Beam Length	Design Fillet @ Beam End	A	Max. Average Fillet*
120 ft.	1 15/16	2 5/16	3 1/16
128 ft.	1 15/16	3 7/16	3 5/8

\*Note: The Maximum Average Fillet is based on a beam with zero camber. This is the absolute largest fillet the beam can experience.

4. Rerun the In-House program using the strand pattern found in steps 1 & 2. Each beam length will need to be analyzed using the Maximum Average Fillet found above. The Maximum Average Fillet is assumed to be a constant depth over the entire length of the beam and should be used in the calculation of the dead load weight (Non-composite DL or "On Precast DL") value in the design program. Check the stresses in the beam against the allowable values.

NOTE: If you are designing simple beams, the design fillet for each span's beam design will be used independently to determine a Maximum Average Fillet.

# Span Design Details

## General

Class "BD" (4,000 psi) or Class "BDX" (4,500 psi)

1. ~~Concrete used in slab shall be Class "AA" (4,000 psi). Reinforcing shall be Grade 60.~~
2. The design of longitudinal slab steel should start with #4 bars top & bottom then progress to larger bar sizes as required by design.
3. Transverse Slab Steel is typically #5 Bars. ~~Transverse reinforcing consists of 'harped' bars (A bars) and straight bars (B & C bars). See Figure 8~~

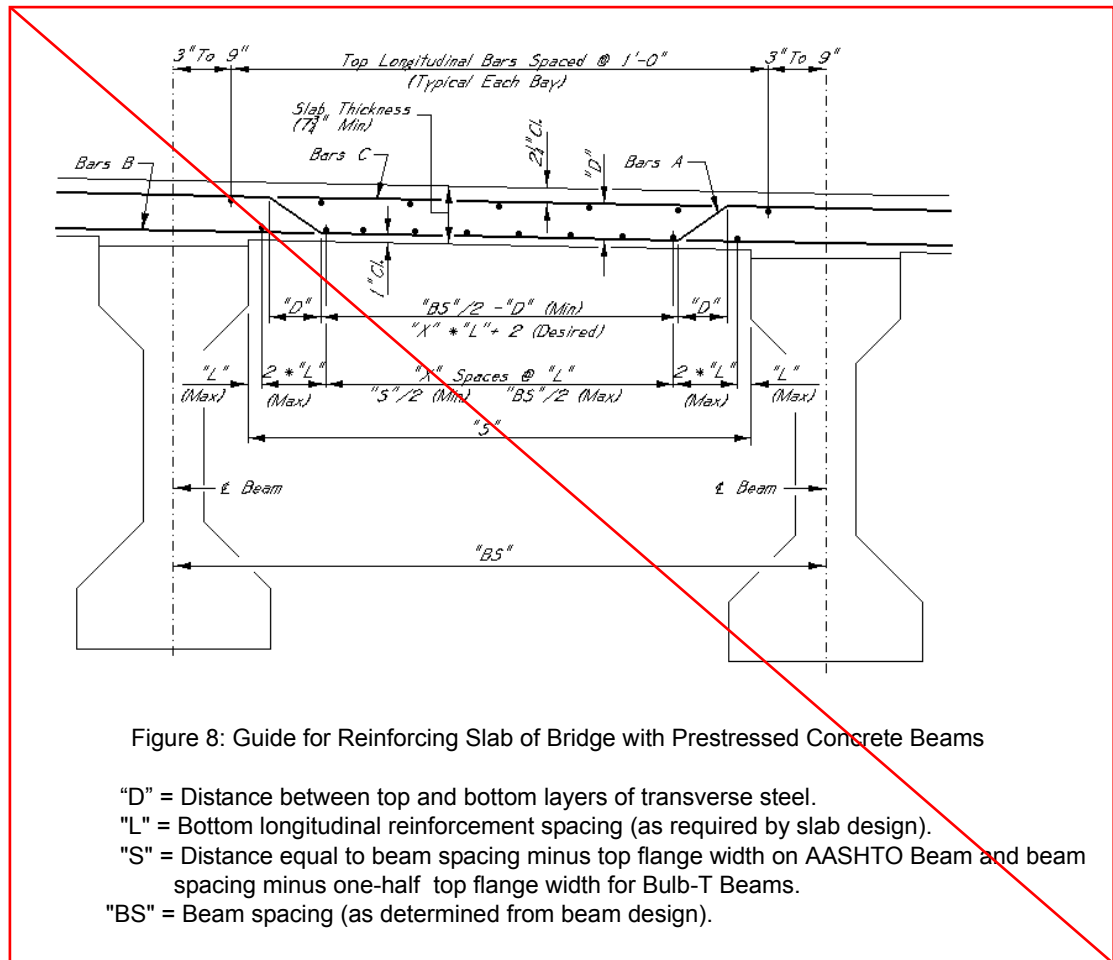

4. Reinforcing steel lengths should be rounded to the nearest 1/2".
5. Railing joint spacing may vary between 20 - 30 feet.
6. 3"x8" Drain holes are used as needed in spans. Typically drain holes are spaced at 10 foot intervals.
  - a. No deck drains shall be placed where it will drain on the approach roadway spill-thru embankment unless the embankment is paved.
  - b. No deck drains shall be placed on a bridge where it will drain on the travelway, shoulder or embankment of the roadway or railway below.
7. On skewed spans the acute corners of the slab should be reinforced using #5 bars placed top & bottom of slab. These bars should be placed as shown in Figure 9.

(continued)

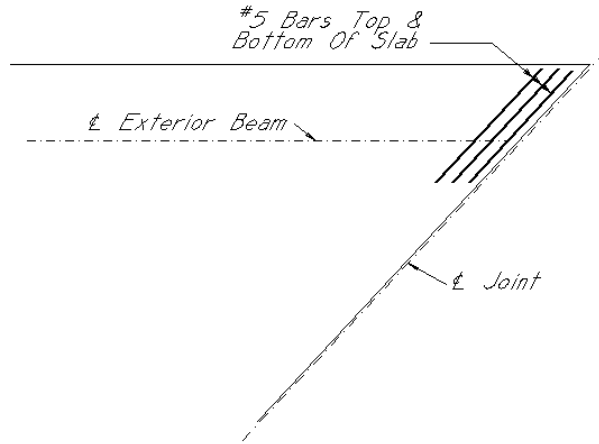

Figure 9: Acute Corner Detail

8. Railing terminating at the ends of a skewed bridge should be detailed as shown in Figures 10 and 11.

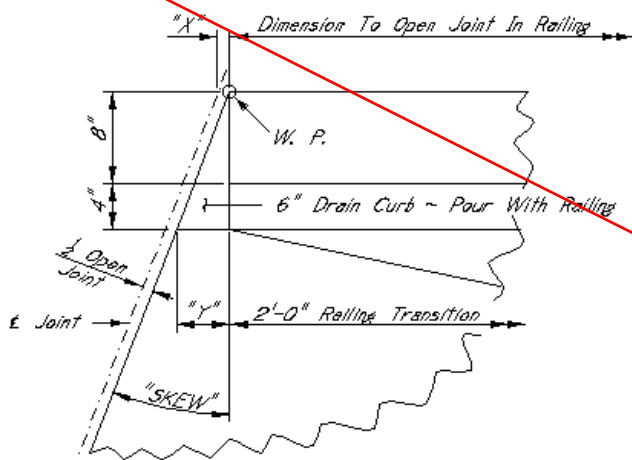

Figure 10: Detail X

Where: "X" = "1/2 Open Joint" / Cos "Skew"  
 "Y" = 1'-0" x Tan "Skew"

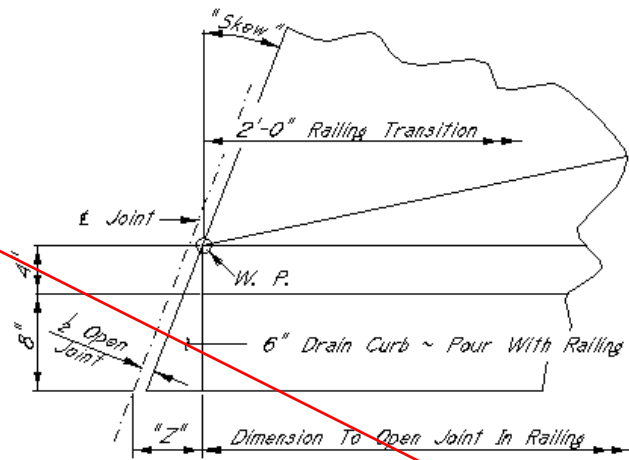

Figure 11: Detail Y

Where: "Z" = "X" + "Y"

9. For curved spans, the distance from chord to arc should be shown on the plans at mid-span or at the point where the distance is a maximum.

## Simple Spans

1. When two skewed simple spans meet, the ends of the railing should be constructed such that the rail is squared up. See Figure 12.

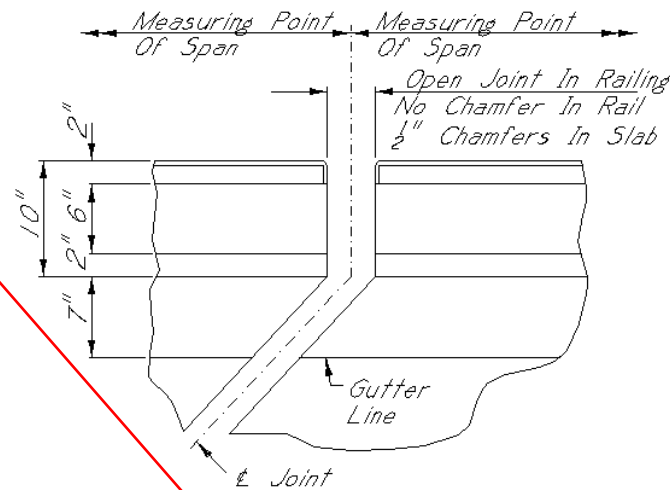

Figure 12: 10" Notch Detail

2. Permissible construction joints can be used to stop long simple span concrete pours. This permissible construction joint should be located along full width diaphragms only and should be designated on the Plan of Spans and Span Section details.
3. End diaphragms are required at the ends of simple spans. End diaphragms are one (1) foot wide and extend to the top of the bottom beam flange. These diaphragms should be detailed as shown in Figures 13 and 14. The dimension indicated by the asterisk (\*) is the controlling dimension and should be maintained for both square and skewed spans.

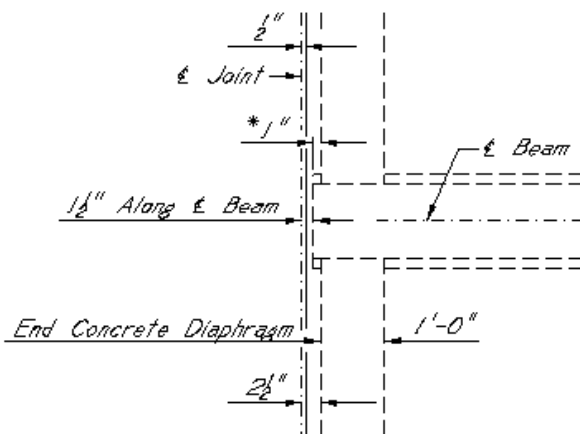

Figure 13: Square End Diaphragm

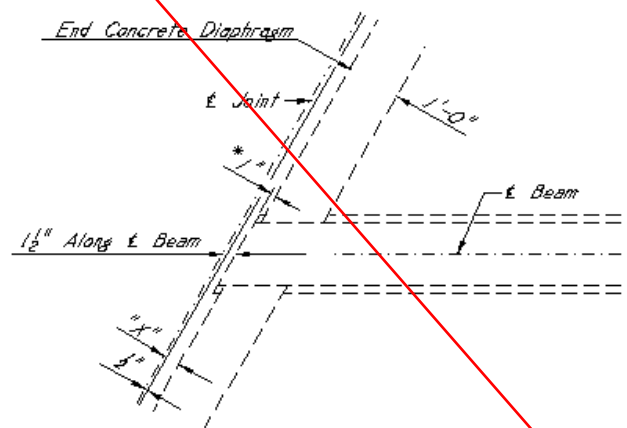

Figure 14: Skewed End Diaphragm

NOTE: "X" =  $1" + (1 \frac{1}{2}" \times \cos \text{"Skew"})$

## Continuous Spans

1. Construction joints between negative and positive moment regions shall be located a minimum of 10 feet from the centerline of bent.
2. A maximum reinforcing size of #7 should be used for the slab reinforcing in the negative moment region.
3. A pouring sequence for all continuous spans should be detailed on the plans. Regions designed as negative moment regions should be poured last in the sequence. The other region (the area between the negative moment regions) should be poured first. When a pouring schedule is used, a note should be placed on the plans. The note should read as follows:  
*"The deck pouring schedule shall be as shown on these plans and any alternate sequence will not be permitted."*
4. Prestressed concrete beams are made continuous for live load by positively connecting the ends of beams together. The continuous ends of these beams have #10 bars cast into the beam to make this connection. See the Beam Reference Guide for the location of these #10 bars.



# Pad Design Details

## General

1. Plain neoprene and laminated bearing pads for AASHTO beams are detailed in the Beam Reference Guide
2. Plain neoprene pads are used at the ends of simple spans and at intermediate bents on continuous spans.
3. Laminated pads are used at the ends of continuous spans.
4. For design purposes, standard pads have a total dead load compression of 1/16".
5. Bulb-I beams require special designed pads. Use the AASHTO Type IV pad dimensions and modify as required by design.
6. When the slope of an individual beam is equal to or greater than 1/8" per foot, the Neoprene Bearing Pads must be beveled. The pad slope should be rounded to the nearest 1/8" per foot slope. Laminated Pads cannot be beveled. In the case where Laminated Pads must be used, a sloped steel plate should be placed between the beam and the Laminated Pad. For additional information about modifying beams that are sloped see the Beam Design Details section of this manual.
7. Bearing pads should be placed according to the limits shown in Figure 15.

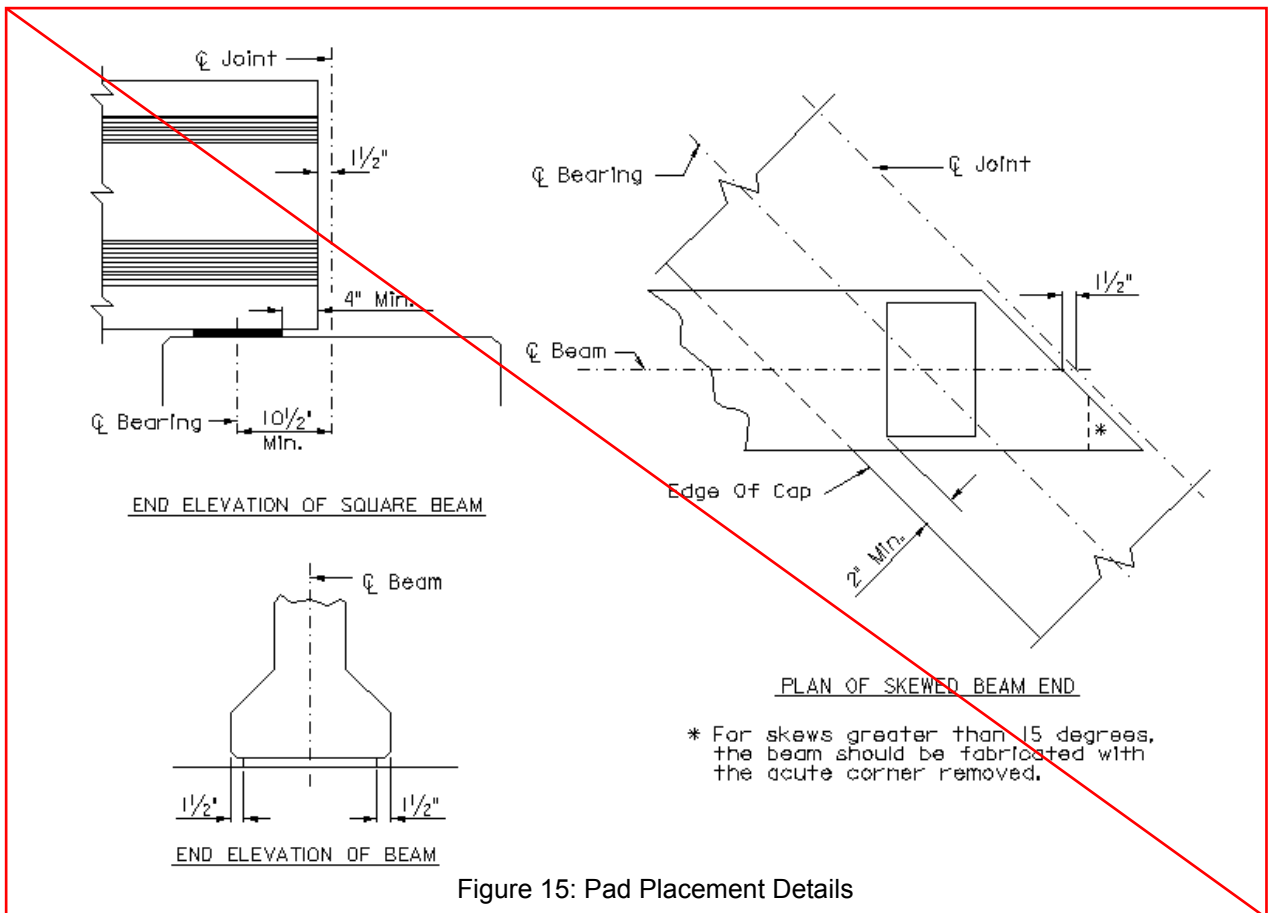



# Bent Design Details

## General

1. In cases where the necessary size and/or number of cap steps would make the clearance from reinforcing steel to concrete surface of step exceed  $5 \frac{1}{2}$ ", an additional mat of steel shall be placed above the main cap reinforcing. This temperature and shrinkage steel shall be #4 bars longitudinal with #5 stirrups spaced with Bars A and tied to main reinforcing steel.
2. Locate stirrup bars (usually A&B) so that the distance from the edge of the pile to the center of the bar on each side of the pile falls within the limits of 2" to 5". When determining this dimension try to keep the spacing of stirrups between the piles in some even spacing. Stirrup spacing should not normally exceed 1'-2" in main cap section.
3. Do not use bar spacing or bar lengths of less than 1/2" increments.
4. Super-elevated bents require shear keys located outside the exterior beams.
5. All bents should be designed using Class "AA" concrete (4,000 psi) and Grade 60 reinforcing.
6. This chapter is written in reference to prestress concrete beam spans. In cases where welded plate girders or steel or concrete box girders are used, the designer can make changes to these requirements.

## End Bents

1. If the bent is in an area of increased superelevation (typically RC to full SE), it should be determined whether the bottom of the cap should be built level or on an incline. Typically an elevation difference of 9" or greater over the length of the endbent requires the cap be built on an incline.
2. The minimum cap step height (longitudinal or transverse) is  $\frac{5}{16}$ ". When the step height is less than  $\frac{5}{16}$ ", the slab thickness is increased on spans with open joints and the pad thickness is increased on bents where the spans are continuous. If the step height is less than or equal to  $\frac{1}{8}$ " it can be ignored.
3. Place piles under bearings as nearly as possible, but DO NOT use pile spacings of less than 1" increments. The dimension from outside pile to end of cap should fall between 1'-9" and 3'-6", never exceeding 3'-6". Maximum spacing of piles in wings is 8'-6".
4. The elevation at the top of the end bent cap under the lowest beam should be shown in the plans. Cap steps should be held to the nearest  $\frac{1}{16}$ ".
5. The dimension from the working point to the gutter line along the bridge end is fixed, regardless of whether the bridge is normal or skewed. Ideally, the dimensions beyond the gutter line should be rounded off so that the length of the cap on either side of the working point will be in even inches and thus the resulting overall length of the cap will be in even inches.

## Intermediate Bents

1. In the calculation of slenderness effects, the effective length factor "k" should be taken as:
  - a. 1.2 in the transverse direction and 1.45 in the longitudinal direction for single pile bents and multiple column frame bents.
  - b. 1.2 in both transverse and longitudinal direction for double pile bents.
  - c. 2.1 in the transverse direction and 1.45 in the longitudinal direction for single column bents.
2. For pile supported intermediate bents, piles should be placed under bearings as nearly as possible. But, DO NOT use pile spacings of less than 1" increments. The number of piles used under each bearing should be determined by the capacity of the piling used. ~~For prestressed concrete piling the following range for ultimate capacity should be used:~~
  - a. 14"x14" - 45-48 tons
  - b. 16"x16" - 55-60 tons
  - c. 18"x18" - 70-75 tons
3. ~~When 5 or more 40 foot spans are made continuous, an alternate battered pile bent may be required at one of the bent locations. Also, a special laminated pad design may be required.~~
4. The dimension from exterior face of exterior beam to end of cap should not be less than 1'-0". Piles should have a minimum of 6" clearance from the edge of pile to the edge of the cap (minimum of 6" between piling on double pile bents).
5. The elevation at the top of the bent cap under the lowest beam should be shown in the plans. Cap steps should be held to the nearest 1/16".
6. All steel pile bents are to be encased in concrete. This concrete encasement should extend from approximately three (3) foot below ground to the bottom of the cap.
7. Brush deflectors should be used on bents in areas where brush or other debris could collect around the piling.

## Miscellaneous Design Details

### Bridge Joints

1. All open joints in the bridge deck shall be sealed.
2. The following formula should be used to determine the joint width for bridges.  
$$D = 2 \times \alpha \times L \times T$$
Where:  $\alpha = 0.0000060$  for Concrete and  $0.0000065$  for Steel  
 $L =$  one-half Maximum Expansion Length (Expansion length is taken as the span length for simple spans; for continuous spans See Below).  
 $T =$  Temperature variance (usually taken as  $50^\circ \text{F}$ )
3. Maximum expansion length for joints on a continuous bridge is determined according to Figure 16. Typical expansion joint widths are as follows:
  - 1" joint for expansion lengths of 150 ft. or less
  - 2" joint for expansion lengths between 150 to 250 ft.
  - For expansion lengths greater than 250 ft. a special design joint is required.
4. When expansion lengths exceed 250 ft. special design expansion joint and sealing systems shall be used. The system used shall be approved by the Bridge Engineer.

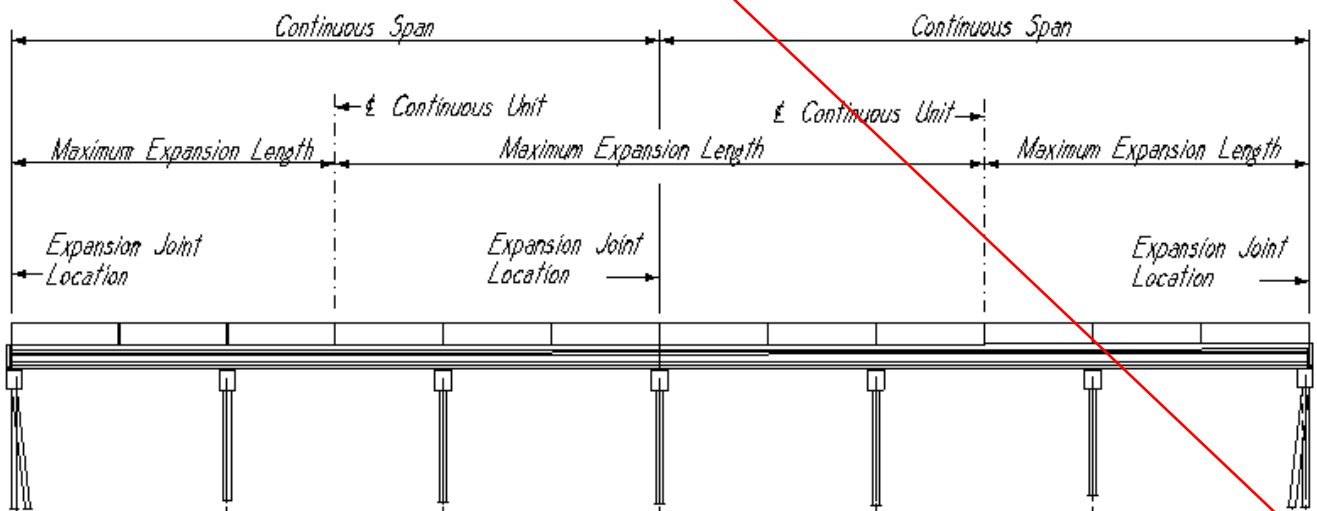
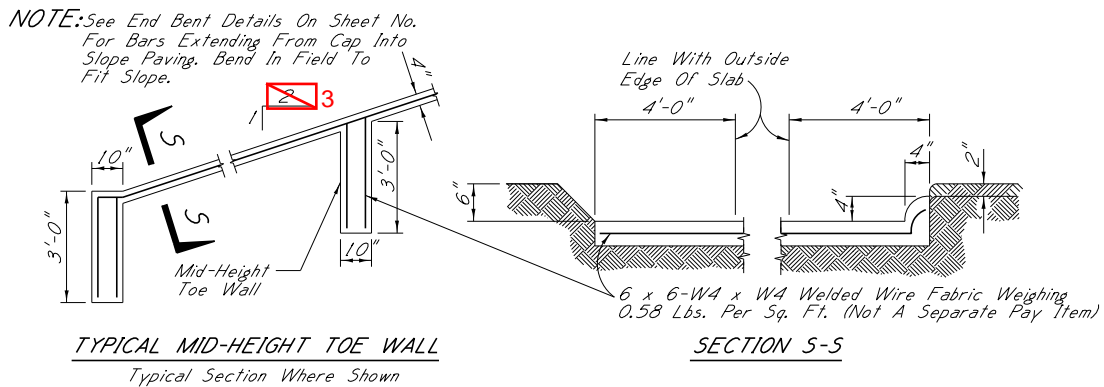
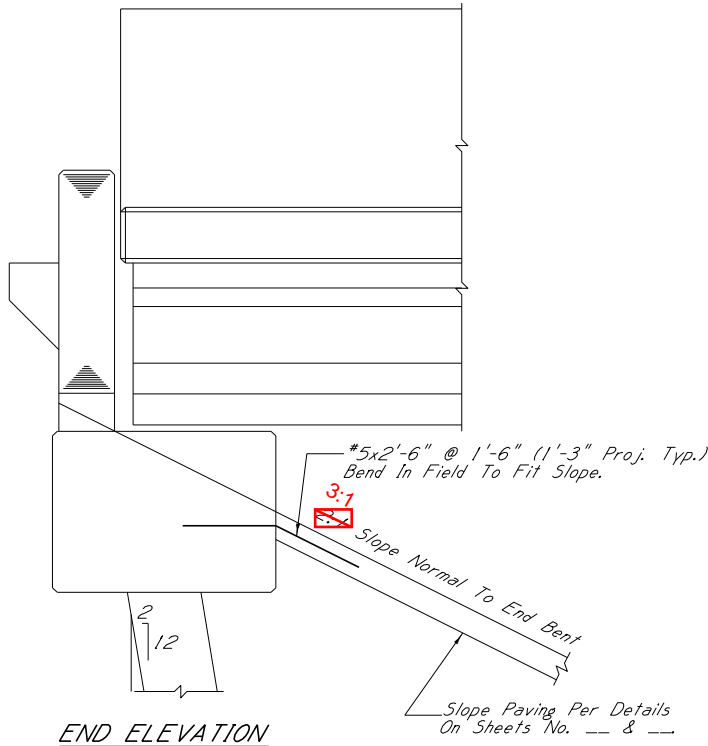

Figure 16: Maximum Expansion Length for Joints

## Slope Paving Details

Slope paving is required on all spill-through type end abutments of grade separation structures.

1. Where twin bridges exist having a nominal median width (approximately 88 ft. or less c.c. lanes), slope paving shall be extended between the bridges and included in bridge quantities.
2. A mid-height (lug) toe wall shall be used when fill height is 10 ft. and greater. All toe walls shall be 10"x3'-0".
3. Use a vertical toe wall at the top of the slope paving for that portion of slope paving between twin bridges. This toe wall shall be 10"x3'-0".
4. Slope paving shall be tied to the front face of the end bent caps by using reinforcing projecting from the caps. (Typically: #5x2'-6" Spaced at 1'-6" with 1'-3" projection into cap.)
5. The slope paving shall be reinforced using 6x6-W4xW4 welded wire fabric.



### SLOPE PAVING DETAILS

Figure 17: Slope Paving Details

## Pile Encasement

On all projects requiring steel piling, the exposed portion of the steel piling shall be encased with concrete. The pile encasement shall extend a minimum of 3'-0" below natural ground.

## Reinforcement Development

Development lengths for reinforcement should comply with current AASHTO Specifications.

## Bridge Pay Items

Bridge pay items should be listed in ascending order by pay item number in the quantity blocks on the bridge plans. Only the pay items used should be listed. All standard pay items are listed in the Mississippi Standard Specifications for Road and Bridge Construction.

## Bridge Title Block

The Title Blocks for the layout sheets (Elevation and Foundation Plans) should include the information shown below.

Bridge Type	Description	Information for Title Block
Overpass	Main facility over lower roadway or railroad	Show bridge stations per main facility In Title Blocks of Layout Sheets (Elevation and Foundation) only, (Line 1) OVERPASS AT STA. (begin bridge station) (Line 2) (Main facility) OVER (lower facility) (example) U.S. HWY 78 OVER MS HWY 25 In all other Title Blocks for this bridge omit Line 2
Underpass	Main facility under upper roadway or railroad	Show bridge stations per facility over In Title Blocks use the main facility intersecting station where the main facility and the upper facility intersect. In Title Blocks of Layout Sheets (Elevation and Foundation) only, (Line 1) UNDERPASS AT STA. (Station) (Line 2) (Main facility) UNDER (upper facility) (example) U.S. Hwy 78 UNDER MS HWY 25 In all other Title Blocks for this bridge omit Line 2
Bridge	Any roadway across a waterway	Show bridge stations per facility across In Title Blocks of Layout Sheets (Elevation and Foundation) only, (Line 1) BRIDGE AT STA. (begin bridge station) (Line 2) (facility) Across (waterway) (example) MS HWY 25 Across Quiver River In all other Title Blocks for this bridge omit Line 2
Detour	Any detour roadway	Show bridge stations per detour road stationing In all Title Blocks: DETOUR BRIDGE AT STA. (begin detour bridge station)

Note: For any bridge site that consists of multiple bridges (i.e. Left and Right lane), line 1 of the title block should be expanded to two lines to include stations for both left and right lane bridges.







**NOTE:** The Deflection Values Shown On The Beam Detail Sheets, Were Prepared Using Average Design And Expansion Coefficients For Concrete. It Is The Contractor's Responsibility To Determine Bridge Center Deflections For Construction. The Contractor Shall Submit Three (3) Copies Of Deck Form Grades, Bridge Center Deflections, And Bridge Center Profiles To The Engineer. The Engineer Shall Review These Submittals And Determine Whether They Shall Include All Calculations, Assumptions And Parameters Used By The Contractor To Determine Bridge Center Deflections And Form Grades. The Engineer Shall Be Stamped As A Mississippi Registered Professional Engineer.

**GENERAL NOTES:**  
1. All Reinforcing Steel Shall Be Class "AA".  
2. Chamfer All Edges 1/4" Unless Otherwise Noted.  
3. See Layout Sheet For Finishing Of Concrete Surfaces.  
4. Provide A Minimum 10% Overlap For Reinforcing Steel To Concrete Surfaces.  
5. Provide Clear Distances.  
6. To Determine The Dimension From Finish Grade To Top Of The Neoprene Pad, It Is To Slope In Trench And That The Original Ground Line Shall Be Used To Determine The Elevation Of The Pad. The General Detail Shows The Pad Elevation For About The Maximum Of The Cambers Not Within These Limits.

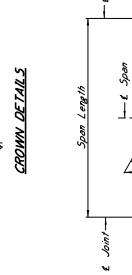
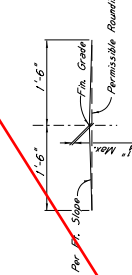

**NOTE:** Drain Holes Shall Be Located 3/4" From Bars B & C With No Bar Cut. All Bars A Way Of Cut In Field.

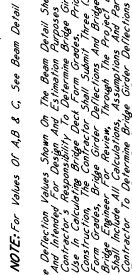

**LIMITS OF TRANSVERSE GROOVING**

NEOPRENE PAD THICKNESS TABLE	
PAD THICKNESS	COMPRESSED PAD THICKNESS

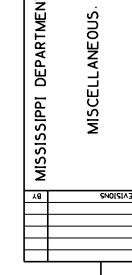

**NOTE:** Seal All Open Joints As Shown On The Layout Sheet. Width Of Joint Shall Be As Indicated. Sealant Shall Be Applied In A Direction Parallel To The Joint. Sealant Shall Be Present At The Time Joint Sealing Begins To Ensure That The Contractor Is Properly Sealed In The Installation Of The Joint Material.

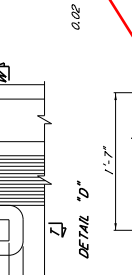
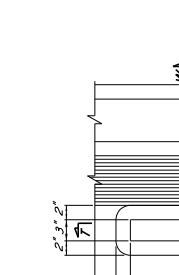

**NOTE:** Continuous Threaded Legs/uds And Diaphragm Inserts Shall Be Fabricated In Accordance With ASTM A36, A572, A578, A588, A595, A633, A639, A690, A709, A744, A746, A753, A755, A757, A768, A770, A772, A774, A776, A778, A780, A782, A784, A786, A788, A790, A792, A794, A796, A798, A800, A802, A804, A806, A808, A810, A812, A814, A816, A818, A820, A822, A824, A826, A828, A830, A832, A834, A836, A838, A840, A842, A844, A846, A848, A850, A852, A854, A856, A858, A860, A862, A864, A866, A868, A870, A872, A874, A876, A878, A880, A882, A884, A886, A888, A890, A892, A894, A896, A898, A900, A902, A904, A906, A908, A910, A912, A914, A916, A918, A920, A922, A924, A926, A928, A930, A932, A934, A936, A938, A940, A942, A944, A946, A948, A950, A952, A954, A956, A958, A960, A962, A964, A966, A968, A970, A972, A974, A976, A978, A980, A982, A984, A986, A988, A990, A992, A994, A996, A998, A1000.

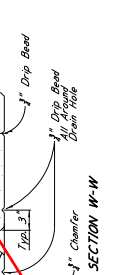

**NOTE:** The Contractor Should Be Aware That The Joint Opening Width Shall Be 60% Of Span Width. Installation Of The Joint Sealer Material Shall Be In Accordance With Manufacturer's Recommendations.



**NOTE:** Joints In Newly Constructed Bridge Decks Shall Be Protected From Damage Until Accepted For Maintenance By The State. Damaged Joints Shall Be Repaired At No Cost To The State.

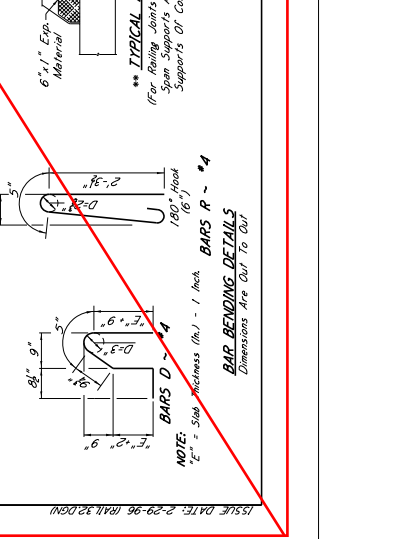
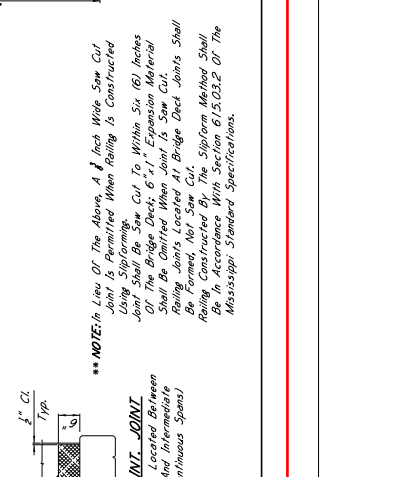
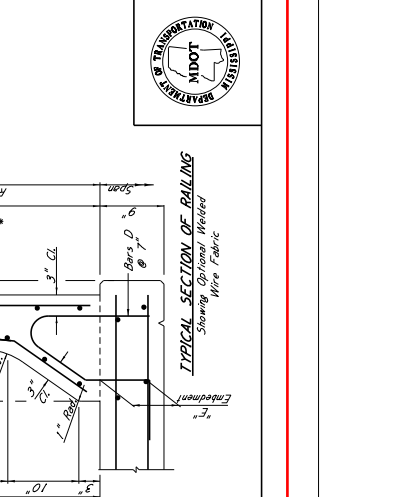
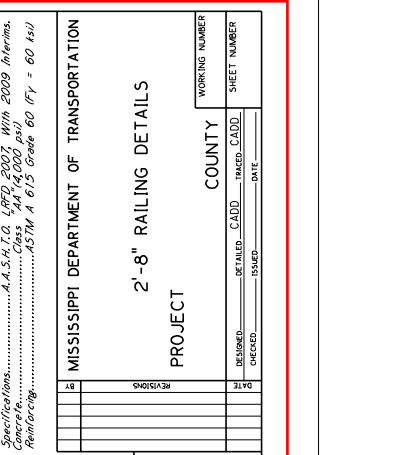
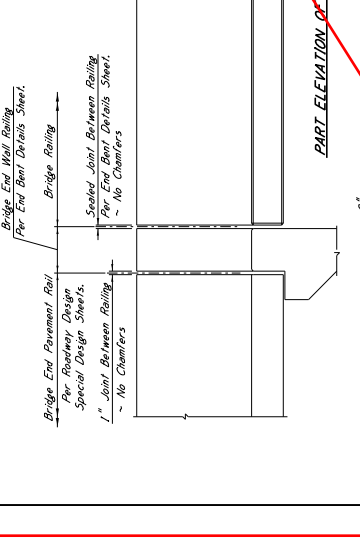
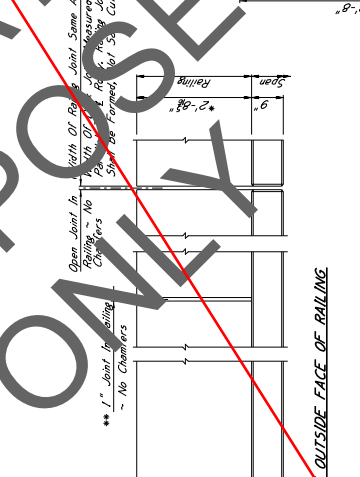
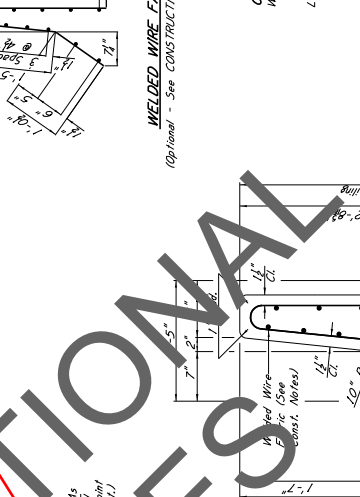
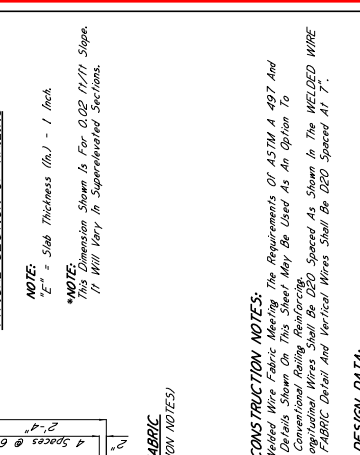
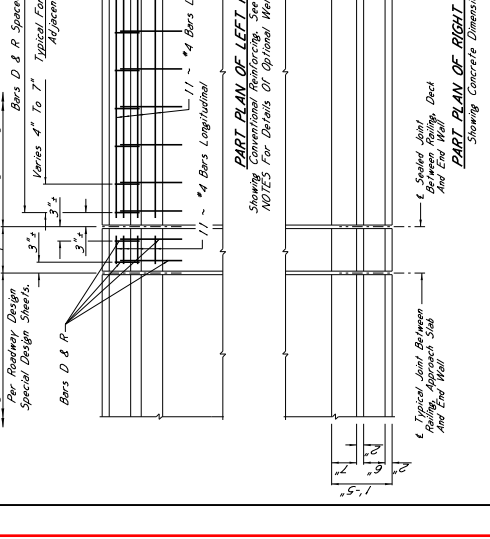
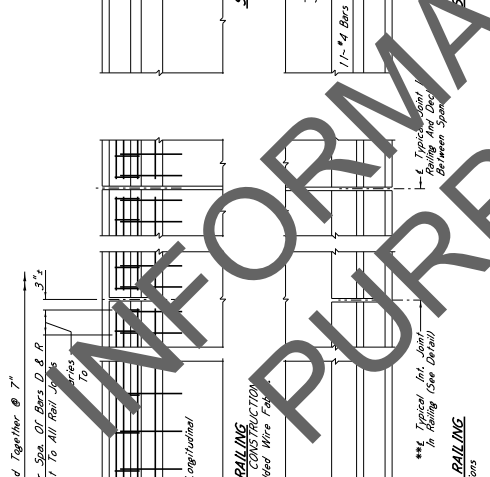
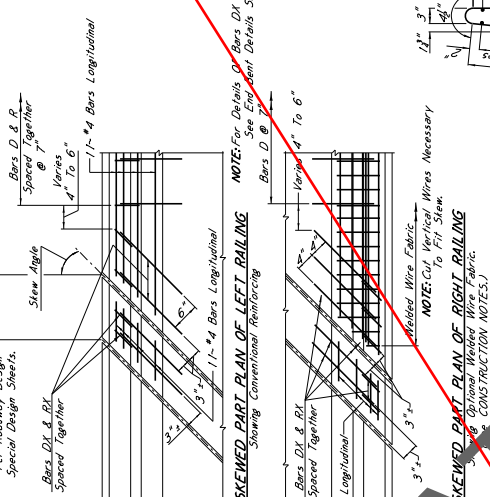
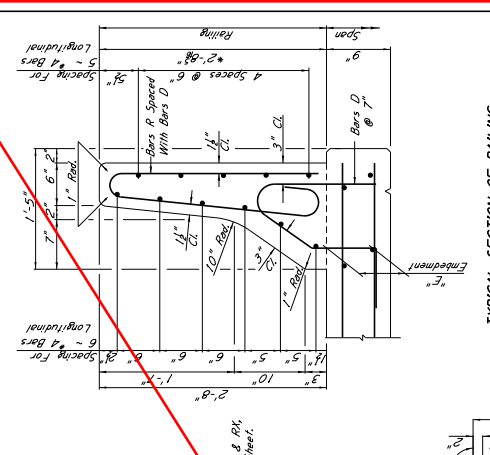

INFORMATIONAL PURPOSES ONLY

**CONSTRUCTION NOTES:**  
 Welded Wire Fabric Meeting The Requirements Of ASTM A 497 And Details Shown On This Sheet May Be Used As An Option To Conventional Railing Reinforcing.  
 Longitudinal Wires Shall Be D20 Spaced As Shown In The WELDED WIRE FABRIC Detail And Vertical Wires Shall Be D20 Spaced At 7".

**DESIGN DATA:**  
 Specifications: A.A.S.T.M. E 1480, 2007 With 2008 Interims, AASHTO LR 114, 2008 and AASHTO LR 114, 2008  
 Reinforcing: ASTM A 615 Grade 60 (Fy = 60 ksi)

**WELDED WIRE FABRIC**  
 Optional - See CONSTRUCTION NOTES)

**BAR BENDING DETAILS**  
 Dimensions Are Cut To Cut



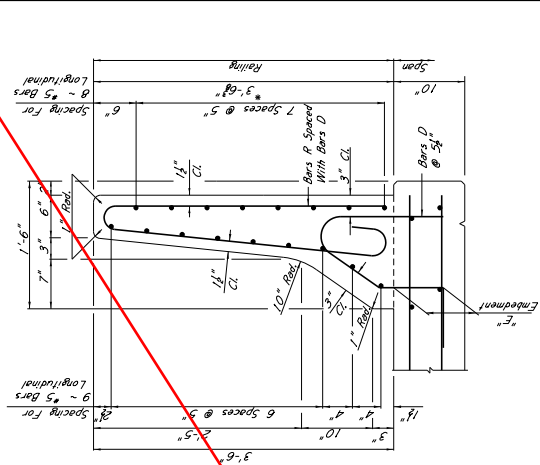

TYPICAL SECTION OF RAILING

NOTE: "E" = Slab Thickness (In.) - 1 Inch  
 \*NOTE: This Dimension Shown Is For 0.02 (1/17) Slope. It Will Vary In Super-elevated Sections.

CONSTRUCTION NOTES:  
 Welded Wire Fabric Meeting The Requirements Of ASTM A 497 And  
 Conforms To The Requirements Of AASHTO M 2009 Interim  
 Specifications May Be Used As An Option To  
 Conventional Railing Reinforcing  
 Longitudinal Wires Shall Be D31 Spaced As Shown In The WELDED WIRE  
 FABRIC Detail And Vertical Wires Shall Be D20 Spaced At 4".

DESIGN DATA:  
 Specifications.....A.A.S.H.T.O. 1999, 2007 With 2009 Interim  
 Specifications.....AASHTO M 2009 (M 4000)  
 Reinforcing.....ASTM A 615 Grade 60 (Fy = 60 ksi)

MISSISSIPPI DEPARTMENT OF TRANSPORTATION	
PROJECT	COUNTY
3'-6" RAILING DETAILS	
WORKING NUMBER	SHEET NUMBER
DESIGNED - CADD	ISSUED - DATE
CHECKED	

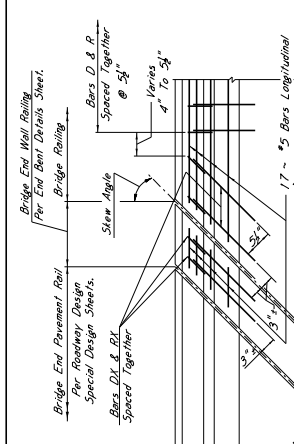
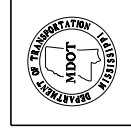

SKEWED PART PLAN OF LEFT RAILING

NOTE: For Welded Wire Fabric Option, Cut  
 Welded Wire To Fit Skew.  
 NOTE: For Details Of Bars D1 & R1,  
 See End Bent Details Sheet.

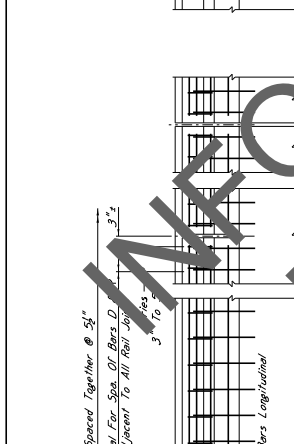

PART PLAN OF LEFT RAILING

NOTE: Typical Joint Width  
 In Rolling (See Detail)

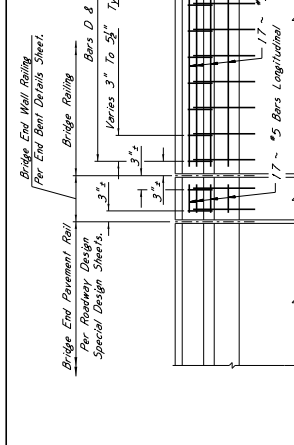

PART PLAN OF RIGHT RAILING

NOTE: Typical Joint Width  
 In Rolling (See Detail)

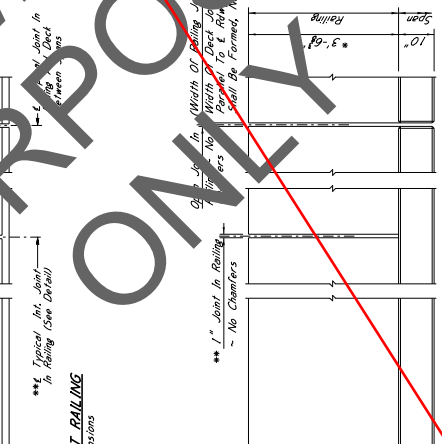

PART ELEVATION OF OUTSIDE FACE OF RAILING

NOTE: In Lieu Of The Above, A 1/2 Inch Wide Saw Cut  
 Joint Is Permitted When Railing Is Constructed  
 Using Slip-forming.  
 Joint Shall Be Saw Cut To Within Six (6) Inches  
 Shall Be Offset When Joint Is Saw Cut.  
 Railing Joints Located At Bridge Deck Joints Shall  
 Be Formed, Not Saw Cut.  
 Railing Constructed By The Slip-form Method Shall  
 Be In Accordance With Section 615.03.2 Of The  
 Mississippi Standard Specifications.

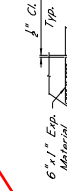

TYPICAL INT. JOINT

NOTE: For Railing Joints Located Between  
 Span Supports And Intermediates  
 Supports Of Continuous Spans

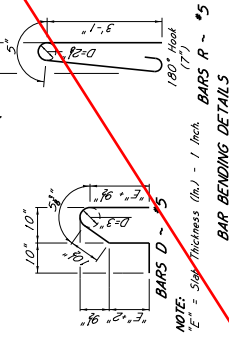

BAR BENDING DETAILS

NOTE: "E" = Slab Thickness (In.) - 1 Inch  
 BARS R - 5  
 Dimensions Are Out To Out

INFORMATIONAL PURPOSES ONLY

STATE PROJECT NO.  
MISS.

1-2" 6-5 Bars  
1-2" 4-10 Dowels  
2" CL  
Typ.

SECTION B-B  
Including Dowel Placement

1-4" 6-5 Bars  
1-4" 4-10 Dowels  
2" CL  
Typ.

SECTION B-B  
Including Dowel Placement

1-6" 7-5 Bars  
1-6" 4-10 Dowels  
2" CL  
Typ.

SECTION B-B  
Including Dowel Placement

1-8" 9-5 Bars  
1-8" 4-10 Dowels  
2" CL  
Typ.

SECTION B-B  
Including Dowel Placement

1-8" 12-5 Bars  
1-8" 4-10 Dowels  
2" CL  
Typ.

SECTION B-B  
Including Dowel Placement

MISSISSIPPI DEPARTMENT OF TRANSPORTATION  
NON-SEISMIC  
14", 16", 18" & 20" SQUARE  
PRESTRESSED CONCRETE PILES  
PROJECT

DATE \_\_\_\_\_  
REVISIONS

DESIGNED: N.A. DRAWN: N.A. MADE: J.A.A.  
CHECKED: N.A. ISSUED: \_\_\_\_\_

WORKING NUMBER  
SHEET NUMBER

COUNTY \_\_\_\_\_ DATE \_\_\_\_\_

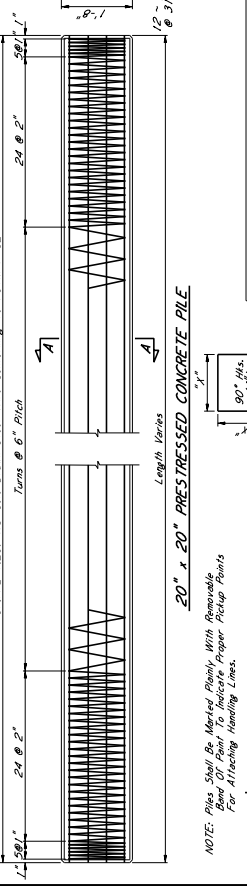
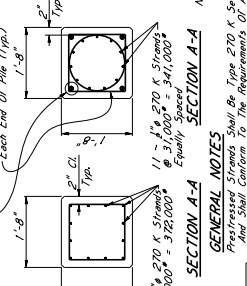
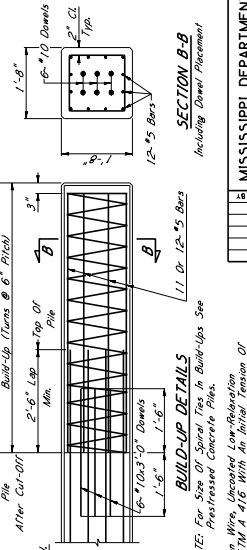
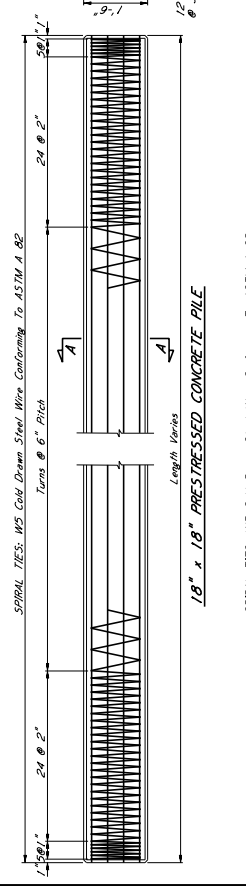
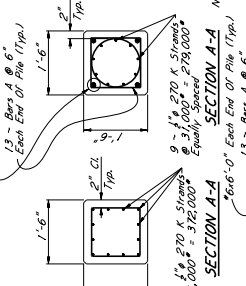
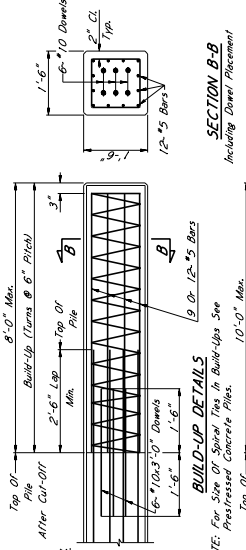
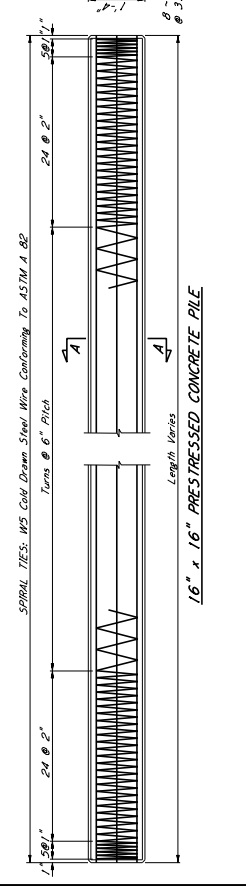
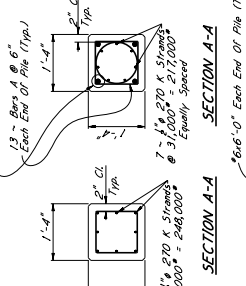
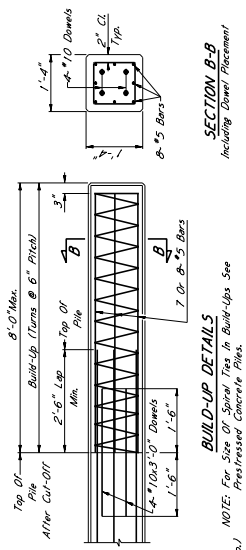
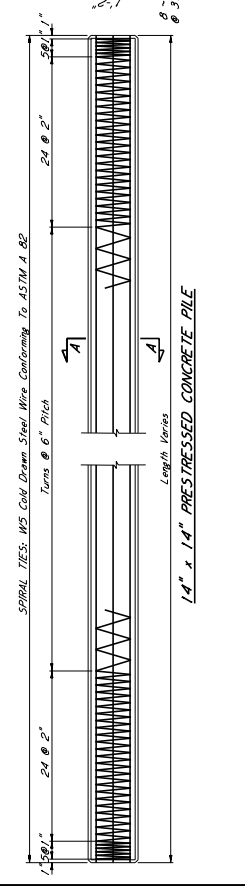
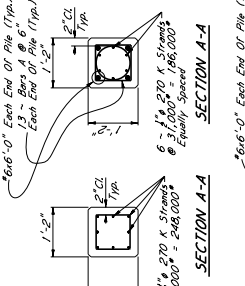
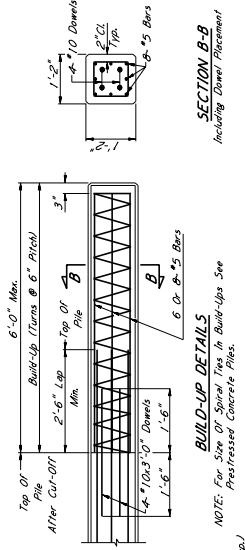

**BUILD-UP DETAILS**  
NOTE: For Size Of Spiral Ties In Build-Ups See Prestressed Concrete Piles.  
8"-10" Max.  
Build-Up Turns @ 6" Pitch  
2'-6" Lsp  
Top Of Pile  
Min.  
6 Or 8-5 Bars  
1'-6" 1'-6" 1'-6"  
4-10 Or 8-5 Dowels  
2" CL  
Typ.

**BUILD-UP DETAILS**  
NOTE: For Size Of Spiral Ties In Build-Ups See Prestressed Concrete Piles.  
8"-10" Max.  
Build-Up Turns @ 6" Pitch  
2'-6" Lsp  
Top Of Pile  
Min.  
7 Or 8-5 Bars  
1'-6" 1'-6" 1'-6"  
4-10 Or 8-5 Dowels  
2" CL  
Typ.

**BUILD-UP DETAILS**  
NOTE: For Size Of Spiral Ties In Build-Ups See Prestressed Concrete Piles.  
8"-10" Max.  
Build-Up Turns @ 6" Pitch  
2'-6" Lsp  
Top Of Pile  
Min.  
9 Or 12-5 Bars  
1'-6" 1'-6" 1'-6"  
4-10 Or 8-5 Dowels  
2" CL  
Typ.

**BUILD-UP DETAILS**  
NOTE: For Size Of Spiral Ties In Build-Ups See Prestressed Concrete Piles.  
10"-10" Max.  
Build-Up Turns @ 6" Pitch  
2'-6" Lsp  
Top Of Pile  
Min.  
11 Or 12-5 Bars  
1'-6" 1'-6" 1'-6"  
4-10 Or 8-5 Dowels  
2" CL  
Typ.

SPRAL TIES: MS Cold Drawn Steel Wire Conforming To ASTM A 62 Turns @ 6" Pitch  
Length Varies  
14" x 14" PRESTRESSED CONCRETE PILE  
SPRAL TIES: MS Cold Drawn Steel Wire Conforming To ASTM A 62 Turns @ 6" Pitch  
Length Varies  
16" x 16" PRESTRESSED CONCRETE PILE  
SPRAL TIES: MS Cold Drawn Steel Wire Conforming To ASTM A 62 Turns @ 6" Pitch  
Length Varies  
18" x 18" PRESTRESSED CONCRETE PILE  
SPRAL TIES: MS Cold Drawn Steel Wire Conforming To ASTM A 62 Turns @ 6" Pitch  
Length Varies  
20" x 20" PRESTRESSED CONCRETE PILE

**GENERAL NOTES**  
Prestressed Strands Shall Be Type 270 K Seven Wire, Uncoated Low-Relaxation And Shall Conform To The Requirements Of ASTM A 416 With An Initial Tension Of 160,000 Lbs. For 14" Pile, 180,000 Lbs. For 16" Pile, 210,000 Lbs. For 18" Pile, 240,000 Lbs. For 20" Pile. Ultimate Strength Of 41,300 Lbs/Inch.  
Piles Shall Be Manufactured In Accordance With Mississippi Standard Specifications For Road And Bridge Construction 2004, With Particular Reference To Sections 711, 803 & 804.  
Spiral Ties Shall Be Tied To All Corner Strands Or Bars.  
5/16" For 20" Pile Or Larger With Ends Of Pile.  
All Reinforcing Steel Shall Conform To ASTM A 615, Grade 60.  
**CONCRETE PILE BUILD-UP NOTE:**  
A Prestress Section May Be Built-Up By Providing Guard Or Channel Steel Or 2x6 Lumber On Top Of Pile As Shown In Build-Up Details. Dowels Shall Be Minimum 3/4" Dia. As Shown In Build-Up Details.  
With An Approved Grout, Concrete Shall Be Class F.

PILE SIZE	MAXIMUM LENGTH "L"		
	Sq. Pile	Two Point	Three Point
14" x 14" SQUARE	54'-0"	78'-0"	109'-0"
16" x 16" SQUARE	60'-0"	84'-0"	118'-0"
18" x 18" SQUARE	64'-0"	91'-0"	127'-0"
20" x 20" SQUARE	66'-0"	93'-0"	129'-0"
CIRCULAR	70'-0"	101'-0"	131'-0"
CIRCULAR	70'-0"	101'-0"	131'-0"
CIRCULAR	70'-0"	101'-0"	131'-0"



NOTE: Piles Shall Be Made Plain With Removable Strands Or Bars At Top For Attaching Handling Lines.

PILE SIZE	MAXIMUM LENGTH "L"
14" x 14" SQUARE	54'-0"
16" x 16" SQUARE	60'-0"
18" x 18" SQUARE	64'-0"
20" x 20" SQUARE	66'-0"
CIRCULAR	70'-0"

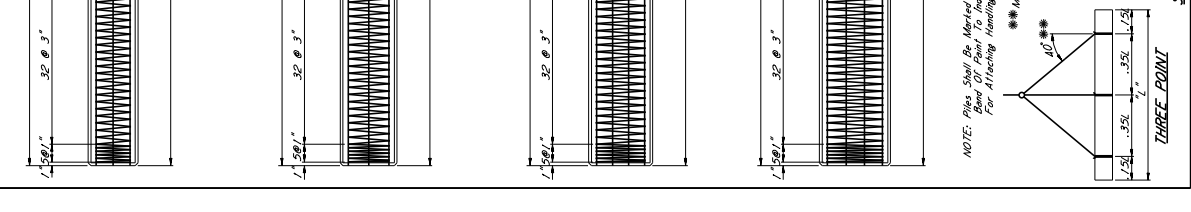
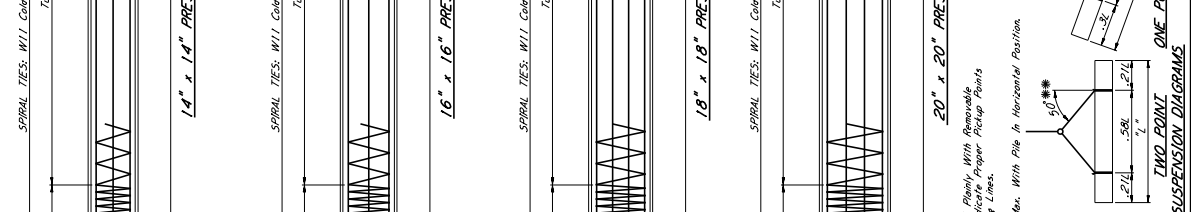
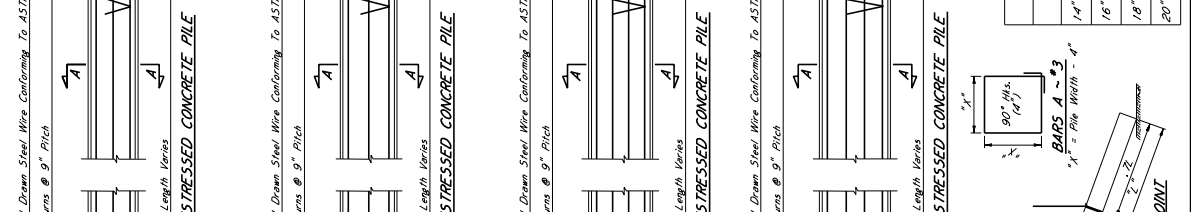
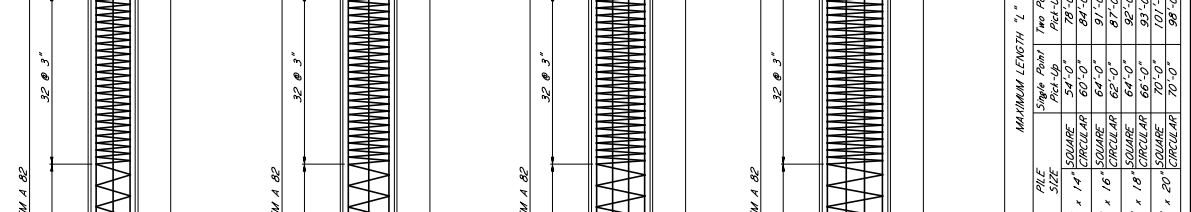
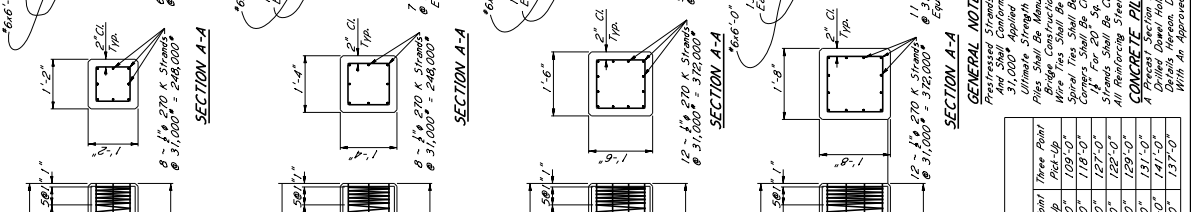
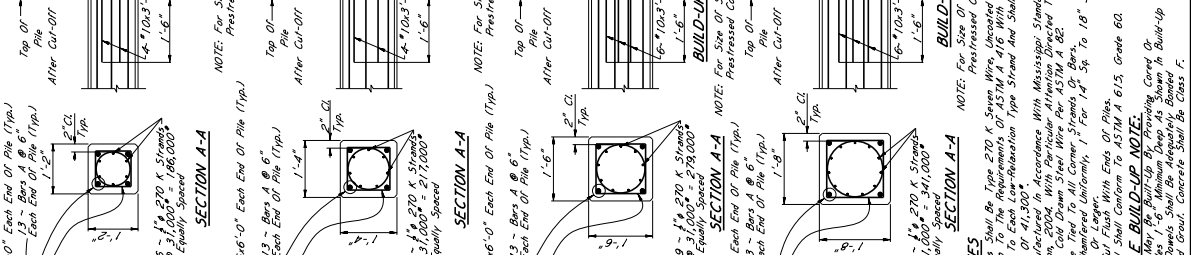
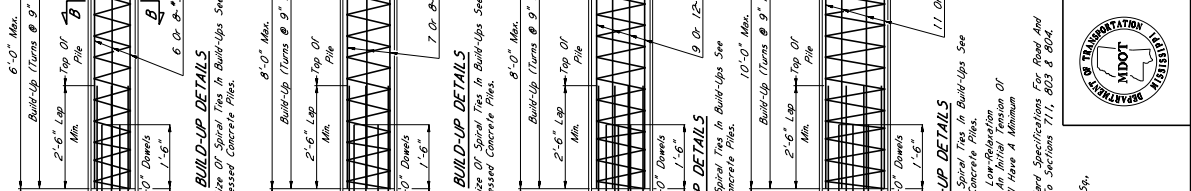
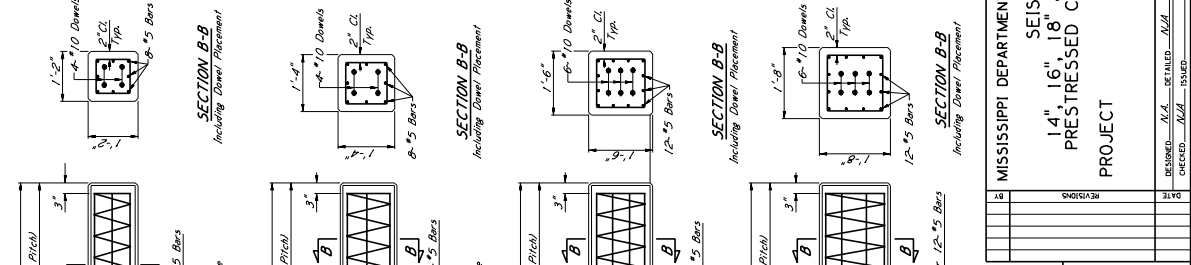

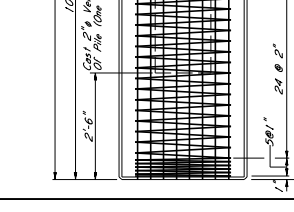
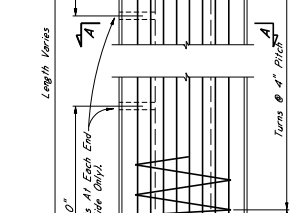
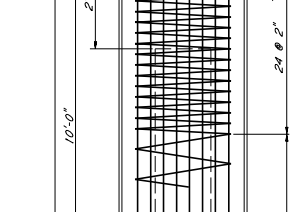
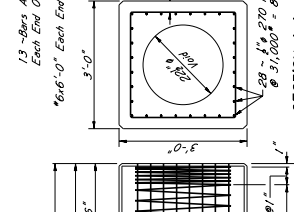
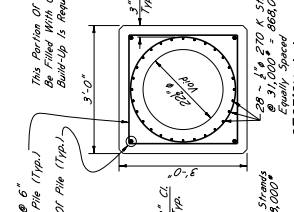
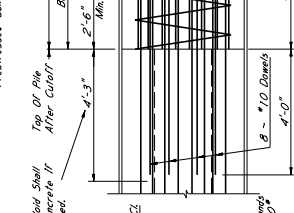
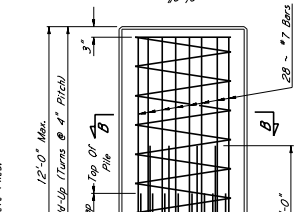
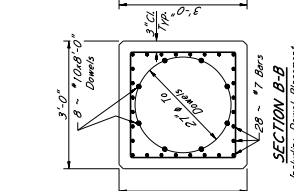
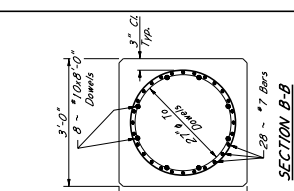
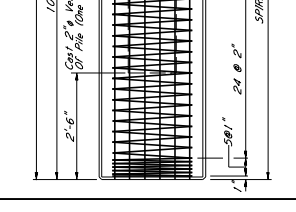
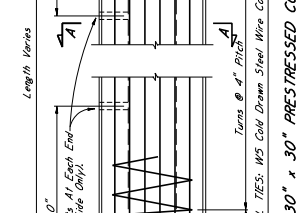
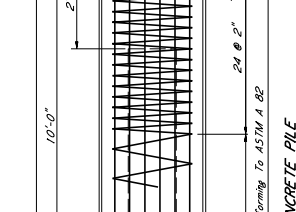
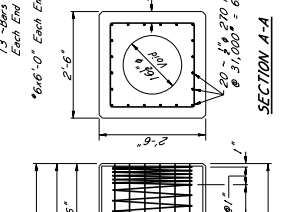
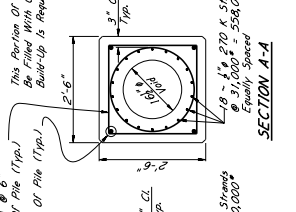
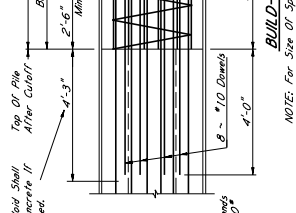
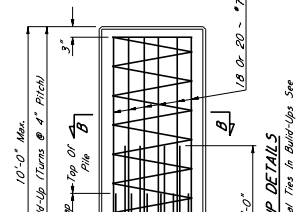
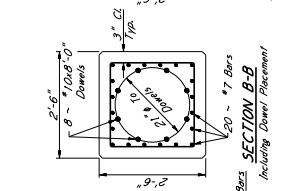
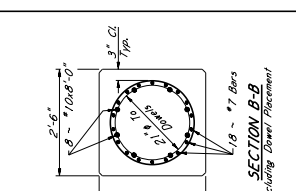
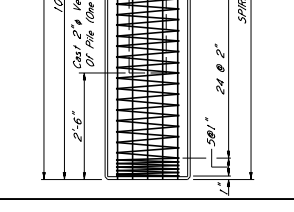
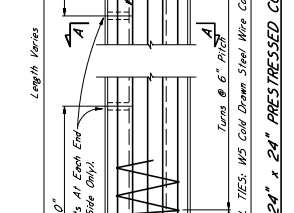
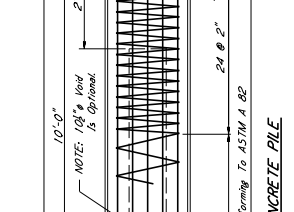
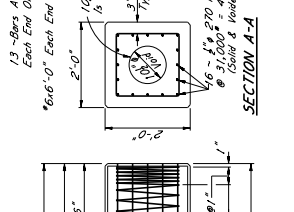
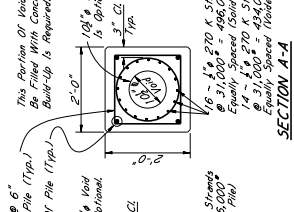
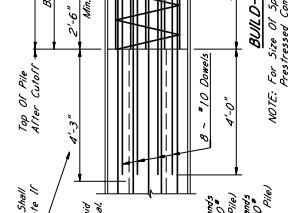
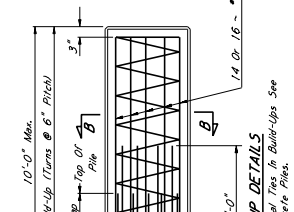
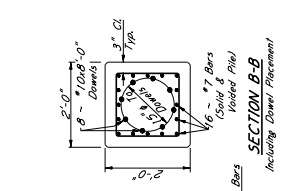

**BUILD-UP DETAILS**  
Including Down Placement  
NOTE: For Size Of Spiral Ties In Build-Ups See Prestressed Concrete Piles.

**BUILD-UP DETAILS**  
Including Down Placement  
NOTE: For Size Of Spiral Ties In Build-Ups See Prestressed Concrete Piles.

**BUILD-UP DETAILS**  
Including Down Placement  
NOTE: For Size Of Spiral Ties In Build-Ups See Prestressed Concrete Piles.

**BUILD-UP DETAILS**  
Including Down Placement  
NOTE: For Size Of Spiral Ties In Build-Ups See Prestressed Concrete Piles.

**BUILD-UP DETAILS**  
Including Down Placement  
NOTE: For Size Of Spiral Ties In Build-Ups See Prestressed Concrete Piles.

**BUILD-UP DETAILS**  
Including Down Placement  
NOTE: For Size Of Spiral Ties In Build-Ups See Prestressed Concrete Piles.

**BUILD-UP DETAILS**  
Including Down Placement  
NOTE: For Size Of Spiral Ties In Build-Ups See Prestressed Concrete Piles.

**BUILD-UP DETAILS**  
Including Down Placement  
NOTE: For Size Of Spiral Ties In Build-Ups See Prestressed Concrete Piles.

**BUILD-UP DETAILS**  
Including Down Placement  
NOTE: For Size Of Spiral Ties In Build-Ups See Prestressed Concrete Piles.

**BUILD-UP DETAILS**  
Including Down Placement  
NOTE: For Size Of Spiral Ties In Build-Ups See Prestressed Concrete Piles.

**BUILD-UP DETAILS**  
Including Down Placement  
NOTE: For Size Of Spiral Ties In Build-Ups See Prestressed Concrete Piles.

**BUILD-UP DETAILS**  
Including Down Placement  
NOTE: For Size Of Spiral Ties In Build-Ups See Prestressed Concrete Piles.

**BUILD-UP DETAILS**  
Including Down Placement  
NOTE: For Size Of Spiral Ties In Build-Ups See Prestressed Concrete Piles.

**BUILD-UP DETAILS**  
Including Down Placement  
NOTE: For Size Of Spiral Ties In Build-Ups See Prestressed Concrete Piles.

**BUILD-UP DETAILS**  
Including Down Placement  
NOTE: For Size Of Spiral Ties In Build-Ups See Prestressed Concrete Piles.

**BUILD-UP DETAILS**  
Including Down Placement  
NOTE: For Size Of Spiral Ties In Build-Ups See Prestressed Concrete Piles.

**BUILD-UP DETAILS**  
Including Down Placement  
NOTE: For Size Of Spiral Ties In Build-Ups See Prestressed Concrete Piles.

**BUILD-UP DETAILS**  
Including Down Placement  
NOTE: For Size Of Spiral Ties In Build-Ups See Prestressed Concrete Piles.

**BUILD-UP DETAILS**  
Including Down Placement  
NOTE: For Size Of Spiral Ties In Build-Ups See Prestressed Concrete Piles.

**BUILD-UP DETAILS**  
Including Down Placement  
NOTE: For Size Of Spiral Ties In Build-Ups See Prestressed Concrete Piles.

**BUILD-UP DETAILS**  
Including Down Placement  
NOTE: For Size Of Spiral Ties In Build-Ups See Prestressed Concrete Piles.

**BUILD-UP DETAILS**  
Including Down Placement  
NOTE: For Size Of Spiral Ties In Build-Ups See Prestressed Concrete Piles.

**BUILD-UP DETAILS**  
Including Down Placement  
NOTE: For Size Of Spiral Ties In Build-Ups See Prestressed Concrete Piles.

**BUILD-UP DETAILS**  
Including Down Placement  
NOTE: For Size Of Spiral Ties In Build-Ups See Prestressed Concrete Piles.

**BUILD-UP DETAILS**  
Including Down Placement  
NOTE: For Size Of Spiral Ties In Build-Ups See Prestressed Concrete Piles.

**BUILD-UP DETAILS**  
Including Down Placement  
NOTE: For Size Of Spiral Ties In Build-Ups See Prestressed Concrete Piles.

**BUILD-UP DETAILS**  
Including Down Placement  
NOTE: For Size Of Spiral Ties In Build-Ups See Prestressed Concrete Piles.

MISSISSIPPI DEPARTMENT OF TRANSPORTATION  
NON-SEISMIC  
24" 30" & 36" SQUARE  
PRESTRESSED CONCRETE PILES  
PROJECT

COUNTY \_\_\_\_\_ DATE \_\_\_\_\_  
DESIGNED: N/A - DETAILED: N/A - TRACED: N/A -  
CHECKED: N/A - ISSUED: \_\_\_\_\_

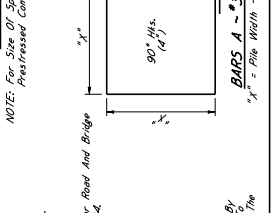
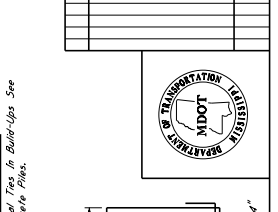

**GENERAL NOTES**  
Prestressed Strands Shall Be Type 270 K Seven Wire, Uncoated Low-Relaxation And Shall Conform To The Requirements Of ASTM A 416 With An Initial Tension Of 100,000 Lbs. Per Strand.  
Piles Shall Be Manufactured In Accordance With Mississippi Standard Specifications For Road And Bridge Construction, 2004 With Particular Attention Directed To Sections 711, 803 & 804.  
Spiral Ties Shall Be Tied To All Corner Strands Or Bars.  
All Piles Shall Be Cast With Ends Uniformly Round.  
A Precast Section May Be Built-Up By Providing Core Or Drilled Dowel Holes 4'-0" Minimum Deep As Shown In Build-Up Details Hereon. Dowels Shall Be Adequately Spaced To Allow For Proper Forming. Concrete Shall Be Class F.  
**PILE VOID FORMING NOTE:** Piles Shall Be Formed In A Manner That Will Allow For Proper Forming. The Material Shall Be Subject To The Approval Of The Engineer. The Engineer Shall Not Be Held Responsible For The Physical Or Structural Integrity Of The Piles.

PILE SIZE	MAXIMUM LENGTH, "L"	
	One Point	Two Point
24" x 24" SQUARE	76'-0"	108'-0"
30" x 30" SQUARE	84'-0"	120'-0"
36" x 36" SQUARE	94'-0"	132'-0"
24" x 24" CIRCULAR	77'-0"	109'-0"
30" x 30" CIRCULAR	83'-0"	117'-0"
36" x 36" CIRCULAR	94'-0"	132'-0"

**CONCRETE PILE BUILD-UP NOTE:**  
Build-Up Details Shall Be Cast In A Manner That Will Allow For Proper Forming. The Material Shall Be Subject To The Approval Of The Engineer. The Engineer Shall Not Be Held Responsible For The Physical Or Structural Integrity Of The Piles.

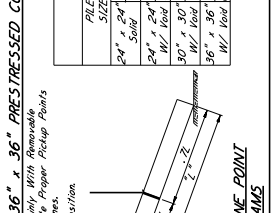

**PILE VOID FORMING NOTE:**  
Piles Shall Be Formed In A Manner That Will Allow For Proper Forming. The Material Shall Be Subject To The Approval Of The Engineer. The Engineer Shall Not Be Held Responsible For The Physical Or Structural Integrity Of The Piles.

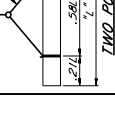
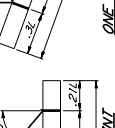
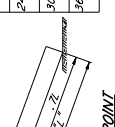
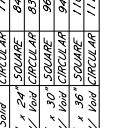
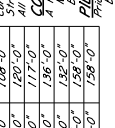
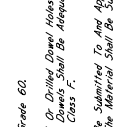
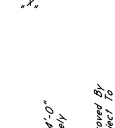
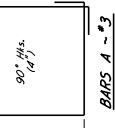
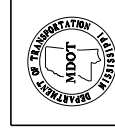

STATE PROJECT NO.  
MISS.

SECTION B-B  
Including Dowel Placement

SECTION B-B  
Including Dowel Placement

SECTION B-B  
Including Dowel Placement

SECTION B-B  
Including Dowel Placement

SECTION A-A  
Including Dowel Placement

SECTION A-A  
Including Dowel Placement

SECTION A-A  
Including Dowel Placement

SECTION A-A  
Including Dowel Placement

SECTION A-A  
Including Dowel Placement

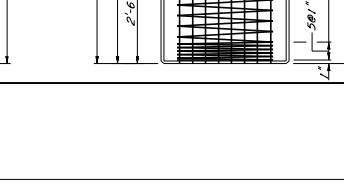
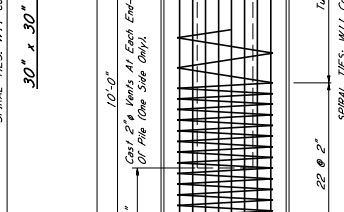
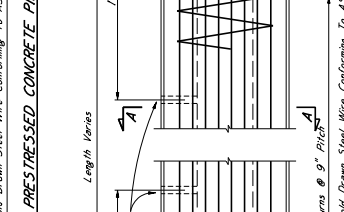
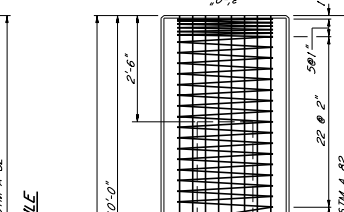
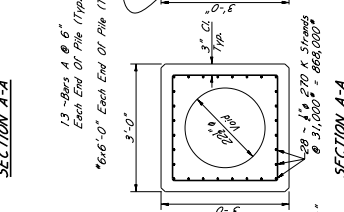
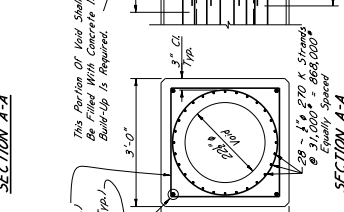
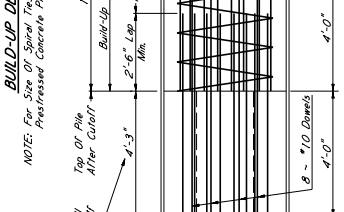
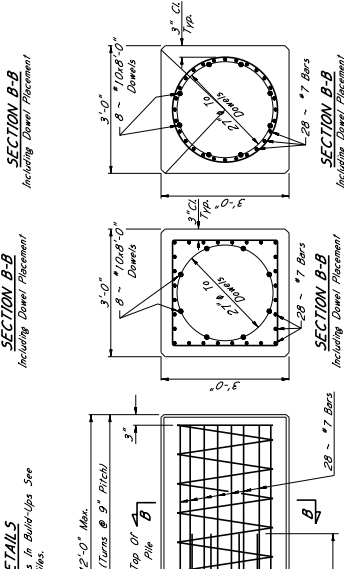
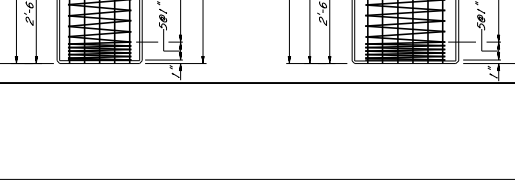
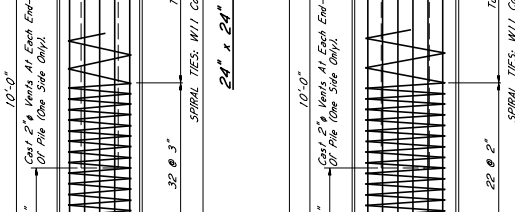
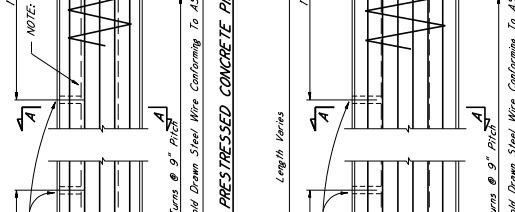
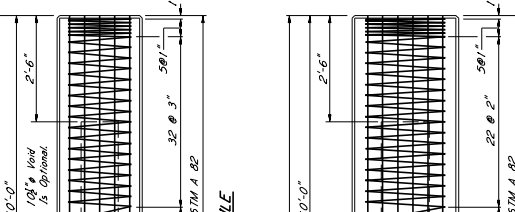
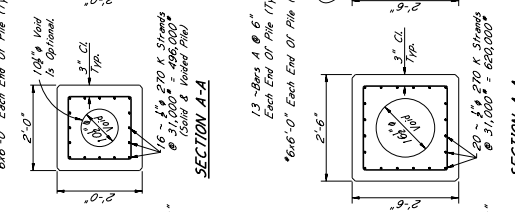
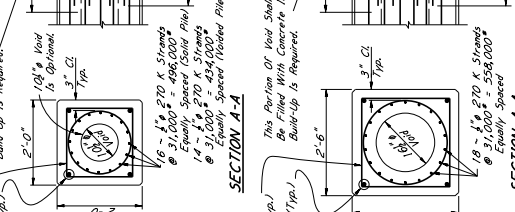
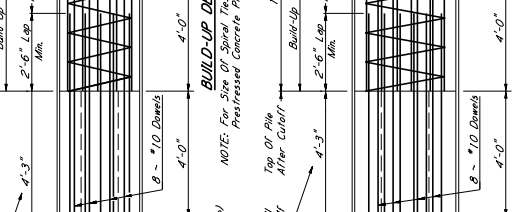
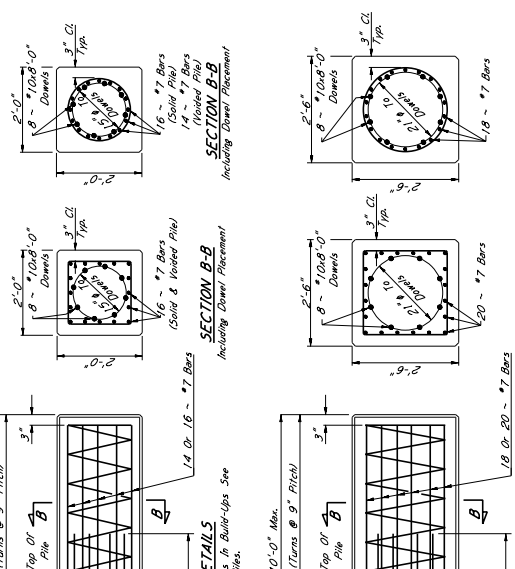

Build-up Details  
 NOTE: For Size Of Spiral Ties In Build-Ups See Prestressed Concrete Piles.

Build-up Details  
 NOTE: For Size Of Spiral Ties In Build-Ups See Prestressed Concrete Piles.

Build-up Details  
 NOTE: For Size Of Spiral Ties In Build-Ups See Prestressed Concrete Piles.

Build-up Details  
 NOTE: For Size Of Spiral Ties In Build-Ups See Prestressed Concrete Piles.

Build-up Details  
 NOTE: For Size Of Spiral Ties In Build-Ups See Prestressed Concrete Piles.

Build-up Details  
 NOTE: For Size Of Spiral Ties In Build-Ups See Prestressed Concrete Piles.

MAXIMUM LENGTH "L"

PILE SIZE	One Point Pile-LB	Two Point Pile-LB
24" x 24" SQUARE	76'-0"	108'-0"
30" x 30" SQUARE	77'-0"	108'-0"
36" x 36" SQUARE	84'-0"	120'-0"
42" x 42" SQUARE	83'-0"	117'-0"
48" x 48" SQUARE	86'-0"	138'-0"
54" x 54" SQUARE	94'-0"	158'-0"
60" x 60" SQUARE	119'-0"	178'-0"

**GENERAL NOTES**

- Prestressed Strands Shall Be Type 270 K Seven Wire, Uncoated Low-Alloy Steel And Shall Conform To The Requirements Of ASTM A 416 With An Initial Tension Of 110,000 Lbs. Per Strand.
- Concrete Shall Be Made With The Strength Requirements Specified In Sections 711, 803 & 804.
- Concrete Shall Be Made With The Strength Requirements Specified In Sections 711, 803 & 804.
- Concrete Shall Be Made With The Strength Requirements Specified In Sections 711, 803 & 804.
- Concrete Shall Be Made With The Strength Requirements Specified In Sections 711, 803 & 804.
- Concrete Shall Be Made With The Strength Requirements Specified In Sections 711, 803 & 804.
- Concrete Shall Be Made With The Strength Requirements Specified In Sections 711, 803 & 804.
- Concrete Shall Be Made With The Strength Requirements Specified In Sections 711, 803 & 804.
- Concrete Shall Be Made With The Strength Requirements Specified In Sections 711, 803 & 804.
- Concrete Shall Be Made With The Strength Requirements Specified In Sections 711, 803 & 804.

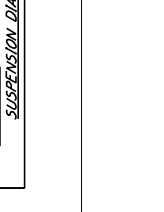

ONE POINT SUSPENSION DIAGRAMS

MISSISSIPPI DEPARTMENT OF TRANSPORTATION  
 SEISMIC  
 24" 30" & 36" SQUARE  
 PRESTRESSED CONCRETE PILES PROJECT

MISSISSIPPI DEPARTMENT OF TRANSPORTATION  
 COUNTY  
 WORKING NUMBER  
 SHEET NUMBER